



VVF53..
VVF53..K



VXF53..

ACVATIX™

2- and 3-port valves with flanged connections, PN 25

VVF53..
VXF53..

From the large-stroke valve line

- High-performance valves for medium temperatures from -20...220 °C
- Valve body of nodular cast iron EN-GJS-400-18-LT or higher
- DN 15...250
- k_{vs} 0.16...630 m³/h
- Flange type 21, flange design B
- VVF53..K with pressure compensation to handle high differential pressure
- Equipable with electro-motoric actuators SAX.., SAV.. or electro-hydraulic actuators SKD.., SKB.., SKC..

Use

In boiler, district heating and refrigeration plants, cooling towers, heating groups, and in air handling units as control or shutoff valves.

For use in closed or open hydraulic circuits (observe cavitation).

Type summary

	Valves	Actuators				SAX.. ³⁾		SKD.. ²⁾		SKB..		SAV ³⁾		SKC..	
		Stroke				20 mm		20 mm		40 mm		40 mm			
		Positioning force				800 N		1000 N		2800 N		1600 N		2800 N	
	PN 25 PN 16 ¹⁾	Data sheet				N4501		N4561		N4664		N4503		N4566	
		Stock no.	DN	k _{vs} [m ³ /h]	S _v	Δp _s	Δp _{max}	Δp _s	Δp _{max}	Δp _s	Δp _{max}	Δp _s	Δp _{max}	Δp _s	Δp _{max}
						[kPa]									
Fluids Preferred flow direction A-AB with fluids for low noise operation and high kvs-values with all actuator types	VVF53.15-0.16	S55208-V100	15	0.16	> 50	2500	1200	2500	1200	2500	1200	-	-	-	-
	VVF53.15-0.2	S55208-V101	15	0.2											
	VVF53.15-0.25	S55208-V102	15	0.25											
	VVF53.15-0.32	S55208-V103	15	0.32											
	VVF53.15-0.4	S55208-V104	15	0.4											
	VVF53.15-0.5	S55208-V105	15	0.5											
	VVF53.15-0.63	S55208-V106	15	0.63											
	VVF53.15-0.8	S55208-V107	15	0.8											
	VVF53.15-1	S55208-V108	15	1											
	VVF53.15-1.25	S55208-V109	15	1.25											
	VVF53.15-1.6	S55208-V110	15	1.6											
	VVF53.15-2	S55208-V111	15	2											
	VVF53.15-2.5	S55208-V112	15	2.5	> 100	1600	750	2100	1100	2000	1150	1250	1150	-	-
	VVF53.15-3.2	S55208-V113	15	3.2											
	VVF53.15-4	S55208-V114	15	4											
	VVF53.20-6.3	S55208-V116	20	6.3											
	VVF53.25-5	S55208-V117	25	5											
	VVF53.25-6.3	S55208-V118	25	6.3											
	VVF53.25-8	S55208-V119	25	8											
	VVF53.25-10	S55208-V120	25	10											
	VVF53.32-16	S55208-V122	32	16											
	VVF53.40-12.5	S55208-V123	40	12.5											
	VVF53.40-16	S55208-V124	40	16											
	VVF53.40-20	S55208-V125	40	20											
VVF53.40-25	S55208-V126	40	25												
VVF53.50-31.5	S55208-V127	50	31.5												
VVF53.50-40	S55208-V128	50	40												
VVF53.65-63	S55208-V129	65	63												
VVF53.80-100	S55208-V130	80	100												
VVF53.100-160	S55208-V131	100	160												
VVF53.125-250	S55208-V132	125	250												
VVF53.150-400	S55208-V133	150	400												
Fluids and Steam Compensated valves are optimized for a single flow direction for fluids and steam. DN 50..150: AB-A DN 200/250: A-AB	VVF53.50-40K	S55208-V134	50	40	> 100	-	-	2500	1250	2500	1250	-	-	2500	1250
	VVF53.65-63K	S55208-V135	65	63											
	VVF53.80-100K	S55208-V136	80	100											
	VVF53.100-150K	S55208-V158	100	150	> 50	-	-	-	-	-	-	-	-	1200	800
	VVF53.125-220K	S55208-V159	125	220											
	VVF53.150-315K	S55208-V160	150	315											
	VVF53.200-450K	S55208-V161	200	450											
VVF53.250-630K	S55208-V162	250	630												

¹⁾ DN 15...50: Flange dimensions for PN 16 and PN 25

DN 65...250: Flange dimensions only for PN 25

²⁾ Usable up to a max. medium temperature of 150 °C

³⁾ Usable up to a max. medium temperature of 130 °C















































DN = Nominal size

k_{vs} = Flow nominal value of cold water (5...30 °C) through the fully opened valve (H₁₀₀) at a differential pressure of 100 kPa (1 bar)

S_v = Rangeability

Δp_s = Maximum permissible differential pressure at which the motorized valve still closes securely against the pressure

Δp_{max} = Maximum permissible differential pressure across the valve's throughport for the entire positioning range of the motorized valve

Valves	Actuators				SAX.. ⁵⁾	SKD.. ²⁾	SKB..	SAV.. ⁵⁾	SKC..																				
	Stroke				20 mm				40 mm																				
	Positioning force				800 N		1000 N		2800 N		1600 N		2800 N																
PN 25 PN 16 ¹⁾	Data sheet				N4501		N4561		N4664		N4503		N4566																
	Stock no.	DN	k _{vs} [m ³ /h]	S _v	Δp _s	Δp _{max}	Δp _s	Δp _{max}	Δp _s	Δp _{max}	Δp _s	Δp _{max}	Δp _s	Δp _{max}															
					[kPa]																								
Steam ³⁾ Exclusive flow direction AB-A for steam. Also useful for maximum close-off pressure Δp _s and maximum differential pressure in operation (Δp _{max}) with fluids. Use with electro-hydraulic actuators only	VVF53.15-0.16	S55208-V100	15	0.16																									
	VVF53.15-0.2	S55208-V101	15	0.2																									
	VVF53.15-0.25	S55208-V102	15	0.25																									
	VVF53.15-0.32	S55208-V103	15	0.32																									
	VVF53.15-0.4	S55208-V104	15	0.4																									
	VVF53.15-0.5	S55208-V105	15	0.5																									
	VVF53.15-0.63	S55208-V106	15	0.63																									
	VVF53.15-0.8	S55208-V107	15	0.8																									
	VVF53.15-1	S55208-V108	15	1																									
	VVF53.15-1.25	S55208-V109	15	1.25																									
	VVF53.15-1.6	S55208-V110	15	1.6																									
	VVF53.15-2	S55208-V111	15	2																									
	VVF53.15-2.5	S55208-V112	15	2.5																									
	VVF53.15-3.2	S55208-V113	15	3.2																									
	VVF53.15-4 ⁴⁾	S55208-V114	15	3.6																									
	VVF53.20-6.3 ⁴⁾	S55208-V116	20	5																									
	VVF53.25-5	S55208-V117	25	5																									
	VVF53.25-6.3	S55208-V118	25	6.3																									
	VVF53.25-8	S55208-V119	25	8																									
	VVF53.25-10 ⁴⁾	S55208-V120	25	8																									
	VVF53.32-16 ⁴⁾	S55208-V122	32	15																									
	VVF53.40-12.5	S55208-V123	40	12.5																									
	VVF53.40-16	S55208-V124	40	16																									
VVF53.40-20	S55208-V125	40	20																										
VVF53.40-25 ⁴⁾	S55208-V126	40	23																										
VVF53.50-31.5	S55208-V127	50	31.5																										
VVF53.50-40	S55208-V128	50	40																										
VVF53.65-63	S55208-V129	65	63																										
VVF53.80-100	S55208-V130	80	100																										
VVF53.100-160 ⁴⁾	S55208-V131	100	150																										
VVF53.125-250 ⁴⁾	S55208-V132	125	220																										
VVF53.150-400 ⁴⁾	S55208-V133	150	360																										
					Δp _{max} [kPa] <table border="1" style="display: inline-table; margin-left: 10px;"> <tr> <td></td> <td></td> <td></td> <td></td> <td></td> <td></td> <td></td> <td></td> <td></td> <td></td> <td></td> <td></td> <td></td> <td></td> <td></td> </tr> </table>																								
																													
Fluids	VXF53.15-1.6	S55208-V140	15	1.6																									
	VXF53.15-2.5	S55208-V141	15	2.5																									
	VXF53.15-4	S55208-V142	15	4																									
	VXF53.20-6.3	S55208-V144	20	6.3																									
	VXF53.25-6.3	S55208-V145	25	6.3																									
	VXF53.25-10	S55208-V146	25	10																									
	VXF53.32-16	S55208-V148	32	16																									
	VXF53.40-16	S55208-V149	40	16																									
	VXF53.40-25	S55208-V150	40	25																									
	VXF53.50-40	S55208-V152	50	40																									
	VXF53.65-63	S55208-V153	65	63																									
	VXF53.80-100	S55208-V154	80	100																									
	VXF53.100-160	S55208-V155	100	160																									
	VXF53.125-250	S55208-V156	125	250																									
VXF53.150-400	S55208-V157	150	400																										

- 1) DN 15...50: Flange dimensions for PN 16 and PN 25
DN 65...150: Flange dimensions only for PN 25
- 2) Usable up to a max. medium temperature of 150 °C
- 3) Operate with opposite flow direction with steam
- 4) Reduced k_{vs} value
- 5) Usable up to a max. medium temperature of 130 °C

Note



When using a stem heating element with a medium temperature of below $-5\text{ }^{\circ}\text{C}$, the stem sealing gland must be replaced. In this case, the sealing gland must be ordered separately.

DN	Stock number
DN 15...50	4 284 8806 0
DN 65...150	4 679 5629 0

Spare parts, Rev.-No.

See page 18

Accessories

Product number	Stock number	Description	Note	
ASZ6.6	S55845-Z108	Stem heating element	Required for medium temperatures $< 0\text{ }^{\circ}\text{C}$	
-	4 284 8806 0	Stem sealing gland	When using valves of the V..F53.. lines DN 15...50 with a stem heating element and a medium temperature below $-5\text{ }^{\circ}\text{C}$, the stem sealing gland must be replaced. With the gland 428488060 the valve can be used with water, water with antifreeze and brines between $-20\text{ }^{\circ}\text{C}$ and $150\text{ }^{\circ}\text{C}$.	
-	4 679 5629 0	Stem sealing gland	When using valves of the V..F53.. lines DN 65...150 with a stem heating element and a medium temperature below $-5\text{ }^{\circ}\text{C}$, the stem sealing gland must be replaced. With the gland 467956290 the valve can be used with water, water with antifreeze and brines between $-20\text{ }^{\circ}\text{C}$ and $150\text{ }^{\circ}\text{C}$.	

Adapter type	Stock number	Bolts included	Description	VXF41..	
ALF41B15	S55845-Z110	4x M12x90mm	Adapter for replacing 3-port valves VXF41.. by VXF53.. <ul style="list-style-type: none"> • Due to different dimensions of the bypass flange • Every valve to be replaced requires an adapter • Adapter is supplied with the required number and size of bolts and nuts as well as two suitable flat sealings Replace 3-port valves VXF41.., DN 65...150 by 3-port valves VXF43.. (data sheet N4404).	DN 15	 DN 15 DN 25 DN 40 DN 50 4030723
ALF41B25	S55845-Z111	4x M12x90mm		DN 25	
ALF41B40	S55845-Z112	4x M16x90mm		DN 40	
ALF41B50	S55845-Z113	4x M16x90mm		DN 50	

Equipment combinations

Product number	Description	Stroke	Positioning force	Operating voltage	Positioning signal	Spring return time	Positioning time	LED	Manual adjuster	Auxiliary functions			
SAX31.00	S55150-A105	20 mm	800 N	AC 230 V	3-position	-	120 s	-	Push and fix	1), 2),			
SAX31.03	S55150-A106						30 s			3), 4),			
SAX61.03	S55150-A100			AC/DC 24 V	3-position		0...10 V 4...20 mA 0...1000 Ω			120 s	-	Push and fix	1), 2),
SAX61.03U	S55150-A100-A100									30 s			
SAX81.00	S55150-A102									120 s			
SAX81.03	S55150-A103									30 s			
SAX81.03U	S55150-A103-A100												
SKD32.21	SKD32.21	20 mm	1000 N	AC 230 V	3-position	8 s	Opening: 30 s Closing: 10 s	-	Turn, Position is maintained	1), 2),			
SKD32.50	SKD32.50					-	120 s						
SKD32.51	SKD32.51					8 s							
SKD60	SKD60					-							
SKD62	SKD62			AC 24 V	0...10 V 4...20 mA 0...1000 Ω	15 s	Opening: 30 s Closing: 15 s	✓	Turn, Position is maintained	3)			
SKD62U	SKD62U					-							
SKD62UA	SKD62UA					-							
SKD82.50	SKD82.50					3-position	-	120 s		-	-	1), 2),	
SKD82.50U	SKD82.50U												
SKD82.51	SKD82.51												
SKD82.51U	SKD82.51U	8 s											
SKB32.50	SKB32.50	20 mm	2800 N	AC 230 V	3-position	-	120 s	-	Turn, Position is maintained	1), 2),			
SKB32.51	SKB32.51					10 s							
SKB60	SKB60			AC 24 V	0...10 V 4...20 mA 0...1000 Ω	-	Opening: 120 s Closing: 10 s	✓	Turn, Position is maintained	3)			
SKB62	SKB62					10 s							
SKB62U	SKB62U							-					
SKB62UA	SKB62UA					-							
SKB82.50	SKB82.50			3-position	-	120 s	-	-	1), 2),				
SKB82.50U	SKB82.50U												
SKB82.51	SKB82.51												
SKB82.51U	SKB82.51U	10 s											
SAV31.00	S55150-A112	40 mm	1600 N	AC 230 V	3-position	-	120 s	-	Push and fix	1), 2), 6)			
SAV61.00	S55150-A110			AC/DC 24 V	DC 0...10 V DC 4...24 mA 0...1000 Ω			✓		1), 3), 6), 7)			
SAV61.00U	S55150-A110-A100							3-position		-	1), 2), 6)		
SAV81.00	S55150-A111												
SAV81.00U	S55150-A111-A100												
SKC32.60	SKC32.60	40 mm	2800 N	AC 230 V	3-position	-	120 s	-	Turn, Position is maintained	1), 2),			
SKC32.61	SKC32.61					18 s							
SKC60	SKC60			AC 24 V	0...10 V 4...20 mA 0...1000 Ω	-	Opening: 120 s Closing: 20 s	✓	Turn, Position is maintained	3)			
SKC62	SKC62					20 s							
SKC62U	SKC62U							-					
SKC62UA	SKC62UA					-							
SKC82.60	SKC82.60			3-position	-	120 s	-	-	1), 2),				
SKC82.60U	SKC82.60U												
SKC82.61	SKC82.61												
SKC82.61U	SKC82.61U	18 s											

- 1) Auxiliary switch (optional)
- 2) Potentiometer (optional)
- 3) Position feedback, forced control, selection of valve characteristic
- 4) Optional: Sequence control, selection of acting direction
- 5) Plus sequence control, stroke limitation, and selection of acting direction
- 6) Stem heating element (optional)
- 7) Function module (optional)

Ordering

Example

Product number	Stock number	Description
VXF53.25-6.3	S55208-V145	3-port valve with flange, PN 25
SAX31.03	S55150-A106	Electro-hydraulic actuator

Delivery

Valves, actuators and accessories are packed and delivered as separate items.

Note





Counter-flanges, bolts and gaskets must be provided on site.

Product documentation

• Mounting Instructions	M4030 74 319 0749 0	DN 15...150
	A6V10774961 A5W90000815	DN 200, DN 250
• Basic documentation	P4030	Contains background information and technical basic knowledge of valves





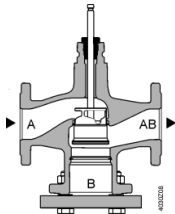
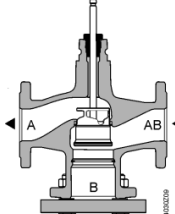

The illustrations below show the basic design of the valves. Constructional features, such as the shape of plugs, may differ.

2-port valves

 Fluids	 Steam (Fluids possible)
 Closing against the pressure	 Closing with the pressure
 <p style="text-align: center;">A → AB</p> <p style="text-align: center;">For use with all actuators</p>	 <p style="text-align: center;">A ← AB</p> <p style="text-align: center;">Use with electro-hydraulic actuators only</p>

2-port valves pressure compensated

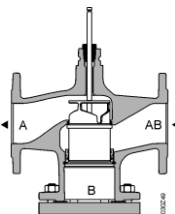
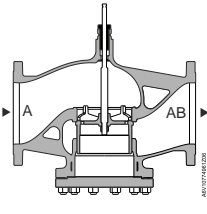

The VVF53..K valves use a pressure-compensated plug. This enables the same type of actuators to be used for the control of volumetric flow at higher differential pressures.

  DN 65...150 Fluids and Steam	  DN 200, DN 250 Fluids and Steam
 Closing with the pressure	 Closing against the pressure
 <p style="text-align: center;">A ← AB</p> <p style="text-align: center;">Use with electro-hydraulic actuators only</p>	 <p style="text-align: center;">A → AB</p> <p style="text-align: center;">Use with electro-hydraulic actuators only</p>

Note

2-port valves do not become 3-port valves by removing the blank flange!

3-port valves

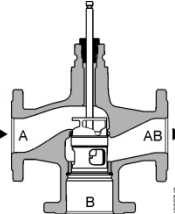
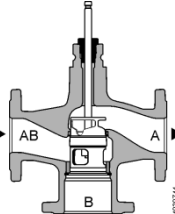
 Fluids	
 Mixing valve (preferred use)	 Diverting valve
 <p style="text-align: center;">A T → AB</p> <p style="text-align: center;">B</p>	 <p style="text-align: center;">AB T → A</p> <p style="text-align: center;">B</p>

Flow chart

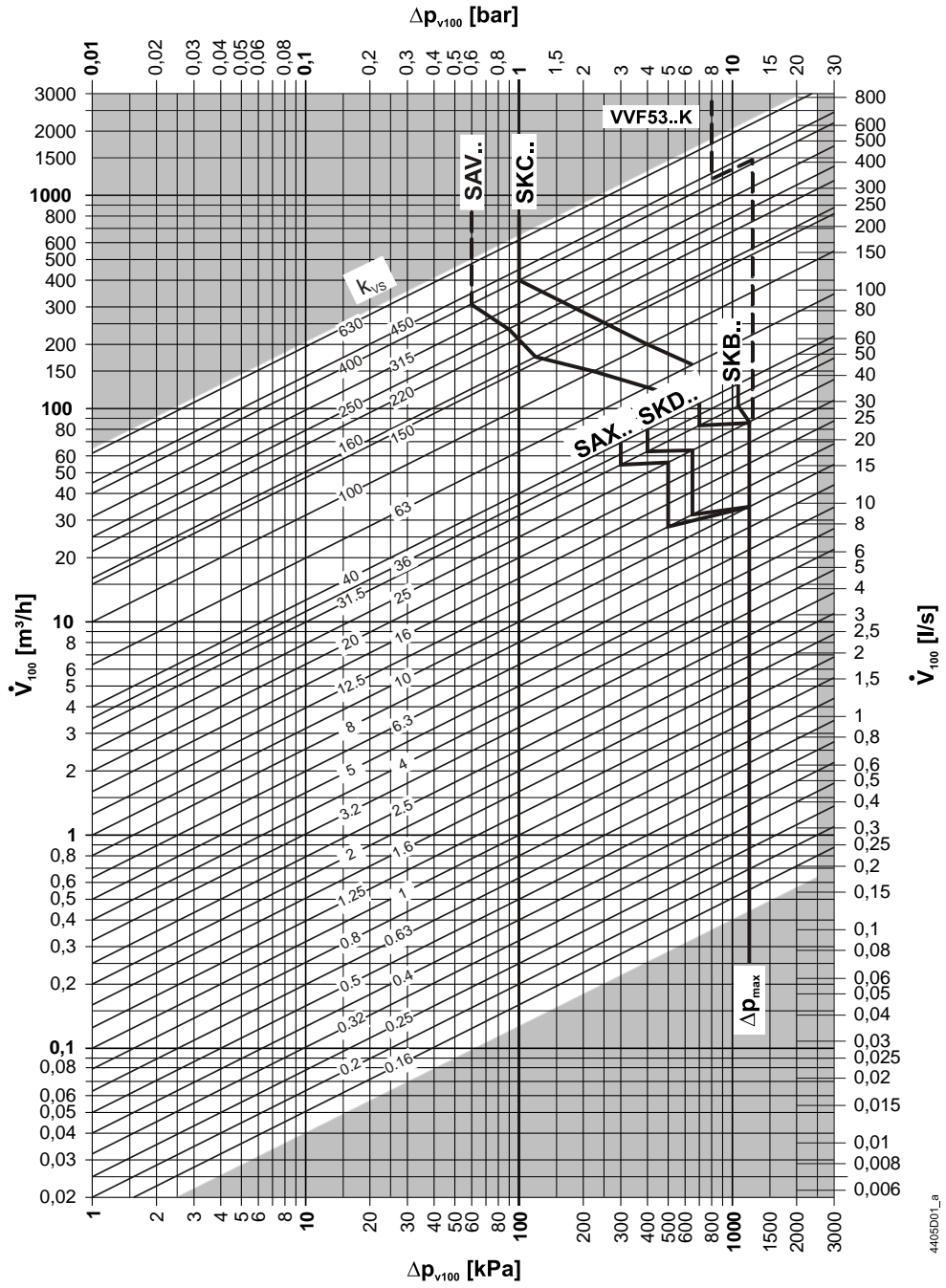

Δp_{max} values apply for the mixing function. Δp_{max} values for the diverting function see table "Type summary", page 2

Δp_{max} values for k_{vs} value 16, DN 32, see table "Type summary", page 2

4405D01_L9

Valve characteristics
2-port valves

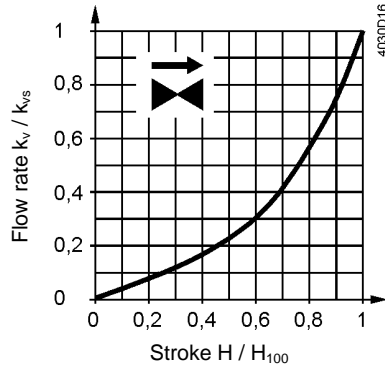

0...30 %: Linear
30...100 %: Equal percentage
 $n_{gl} = 3$ to VDI / VDE 2173
For high k_{vs} values the valve characteristic is optimized for maximum volumetric flow k_{V100} .

For product lines:

- VVF53.125-200
- VVF53.125-250
- VVF53.125-220K
- VVF53.150-315
- VVF53.150-400
- VVF53.150-315K
- VVF53.200-450K
- VVF53.250-630K

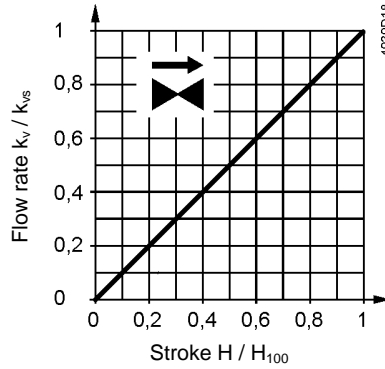

0...100 %: Linear

3-port valves

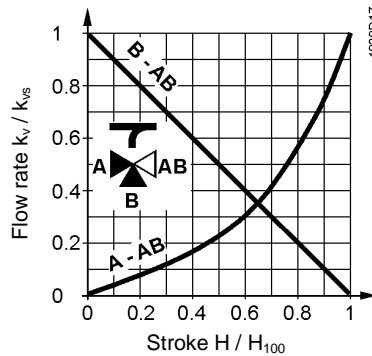

Throughport A-AB

0...30 %: Linear
30...100 %: Equal percentage
 $n_{gl} = 3$ to VDI / VDE 2173

For high k_{vs} values the valve characteristic is optimized for maximum volumetric flow k_{V100} .

Bypass B-AB

0...100 %: Linear

Port AB = constant volumetric flow
Port A = variable volumetric flow
Port B = Bypass (variable volumetric flow)

Mixing: Volumetric flow from port A and port B to port AB
Diverting: Volumetric flow from port AB to port A and port B

For product lines:

- VXF53.125-250
- VXF53.150-400

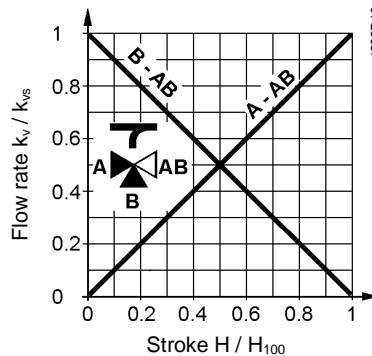

Throughport A-AB

0...100 %: Linear

Bypass B-AB

0...100 %: Linear

Operating pressure and medium temperature

Fluids with V..F53..

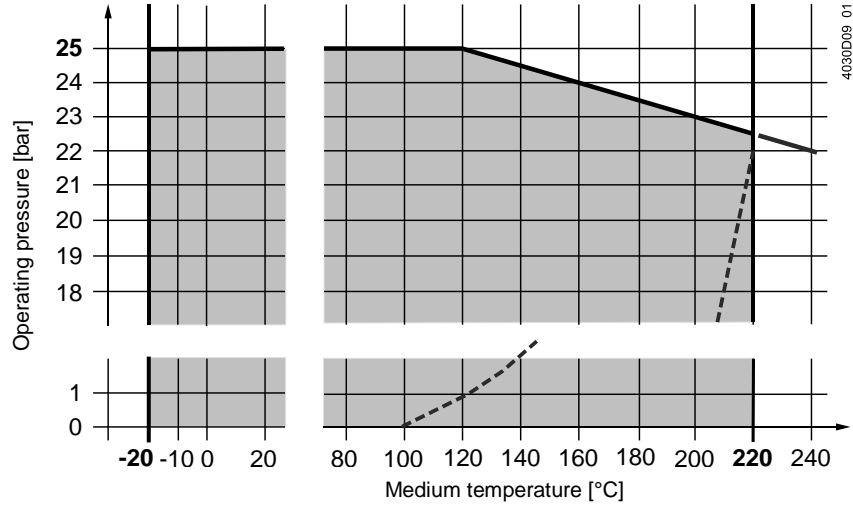

--- Curve for saturated steam; steam forms below this line

— · · Operating pressure according to EN 1092, valid for 2-port valves with blank flange

Operating pressure and operating temperatures according to ISO 7005, EN 1092 and EN 12284

Notes

All relevant local directives must be observed

Saturated steam
Superheated steam
with VVF53..

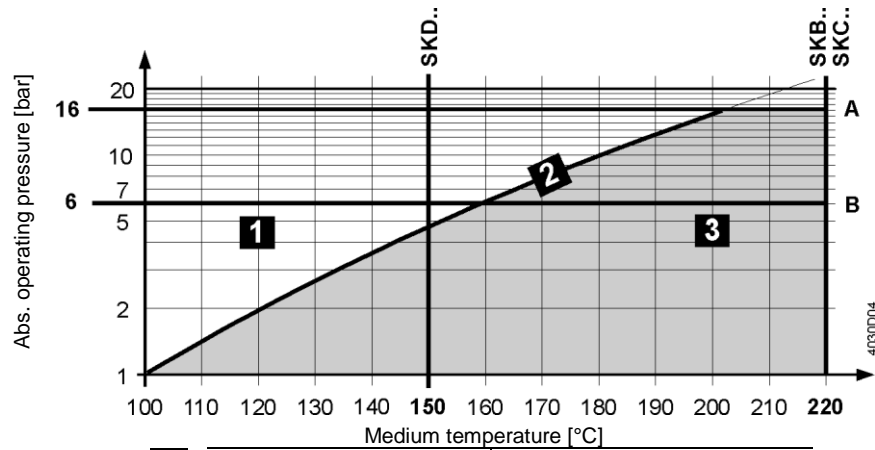

1	Water	-
2	Wet steam	To be avoided
3	Saturated steam Superheated steam	Permissible operating range
A	Subcritical pressure ratio	
B	Supercritical pressure ratio	

Medium compatibility and temperature ranges

Medium	Temperature range		Valve			Note
	T _{min} [°C]	T _{max} [°C]	VVF53..	VVF53..K	VXF53..	
Cold water	1	25	■	■	■	-
Low-temperature hot water	1	130	■	■	■	-
High-temperature hot water ¹⁾	130	150	■	■	■	-
	150	180	■	■	■	-
	180	220	■	■	■	-
Water with antifreeze	-5	150	■	■	■	V..F53: With a medium temperature of below -5 °C, the stem sealing gland must be replaced by DN 15...50: 428488060 DN 65...150: 467956290
	-10	150	■	- ³⁾	■	
	-20	150	■	- ³⁾	■	
Cooling water ²⁾	1	25	■	■	■	-
Brines	-5	150	■	■	■	V..F53: With a medium temperature of below -5 °C, the stem sealing gland must be replaced by DN 15...50: 428488060 DN 65...150: 467956290
	-10	150	■	- ³⁾	■	
	-20	150	■	- ³⁾	■	
Saturated steam	100	150	■	■	-	-
	100	220	■	■	-	-
Superheated steam	120	150	■	■	-	-
	120	220	■	■	-	-
Heat transfer oils	20	220	■	■	■	On the basis of mineral oil
Super-clean water (demineralized and deionized)	1	150	-	-	-	

¹⁾ Differentiation due to saturated steam curve

²⁾ Open circuits

³⁾ VVF53..K can't be used with media below -5 °C due to the compensation sealing material

Fields of use

Fields of use		Valve	
		VVF53..	VXF53..
Generation	Boiler plants	■	■
	District heating plants	■	-
	Refrigeration plants	■	■
	Cooling towers ¹⁾	■	■
Distribution	Heating groups	■	■
	Air handling units	■	■

¹⁾ Open circuits

Engineering notes

Mounting location	Preferably mount the valves at the return, as the temperature is lower there and the strain on the stem sealing gland is lower.
Dirt trap	Mount a dirt filter or dirt trap before the valve to ensure proper functioning, and a long service life of the valve. Remove dirt, welding beads, etc. from the valves and pipes.
Cavitation	Cavitation can be avoided by limiting the pressure differential across the valve depending on the medium temperature and the prepressure.

Mounting notes

Mounting position

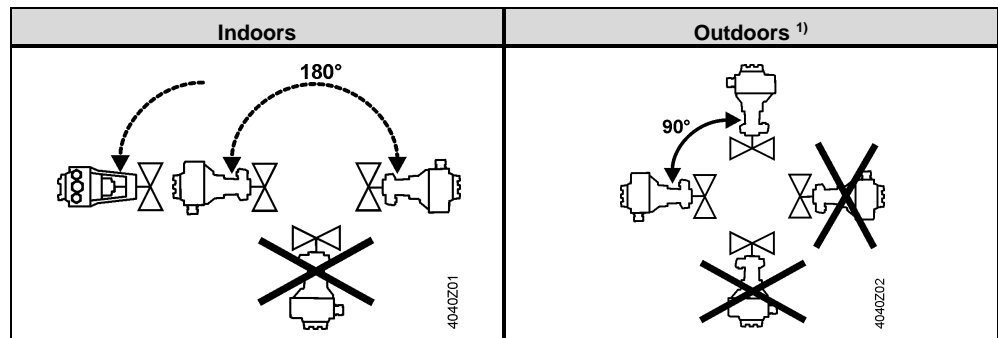

¹⁾ Only in combination with weather shield ASK39.1 and actuators SAX..

Mounting positions apply to both 2- and 3-port valves.

Commissioning notes



The valve may be put into operation only if actuator and valve are correctly assembled.

Note

Ensure that actuator stem and valve stem are rigidly connected in all positions.

Function check

Valve	Throughport A→AB or AB→A	Bypass B→AB
Valve stem extends	Closes	Opens
Valve stem retracts	Opens	Closes

Maintenance notes

The valves are maintenance-free.



When servicing valves or actuators:

- Deactivate the pump and turn off the power supply
- Close the shutoff valves
- Fully reduce the pressure in the piping system and allow pipes to completely cool down

If necessary, disconnect the electrical wires.

Disposal

Do not dispose of the device as unsorted municipal waste.

- Special handling of individual components may be mandated by law or make ecological sense.
- Observe all local and currently applicable laws and regulations.

Warranty

Application-related technical data are guaranteed only when the valves are used in connection with the Siemens actuators listed under "Equipment combinations", page 3.

When used with actuators of other manufacture, any warranty by Siemens becomes void.

Technical Data

Functional data	PN class	PN 25
	Connection	Flange
	Operating pressure	See Section "Operating pressure and medium temperature" page 10
	Valve characteristics ¹⁾	See section "Valve characteristics", page 9
	Leakage rate Throughport	DN 15...150: 0...0.01 % of k_{vs} value (Class IV) DN 200, DN 250: 0...0.02 % of k_{vs} value
	Bypass Bypass	0.5...2 % of k_{vs} value with SKD..., SKB..., SKC.. 0...0.05 % of k_{vs} value with SAX..., SAV..
	Permissible media	See table "Medium compatibility and temperature ranges", page 11
	Medium temperature	-20...220 °C ²⁾ VVF53..K: -5...220 °C
	Rangeability	DN 15, $k_{vs} \leq 1.25 \text{ m}^3/\text{h}$: >50 DN 15...150: >100 DN 200, DN 250: >50
	Nominal stroke	Up to DN 50: 20 mm From DN 65: 40 mm
	Materials	Valve body
Blank flange VVF..		DN 15...150: P265GH DN 200, DN 250: CK25
Valve stem, seat, plug		Stainless steel
Stem sealing gland		Stainless steel DN 15...150: FEPM (silicone-free) DN 200, DN 250: PTFE (not silicone-free)
Compensation sealing		Stainless steel DN 50...150: FEPM (silicone-free) DN 200, DN 250: PTFE+carbon (not silicone-free)
Adapter ALF41B..		Steel S235JRG2
Norms and directives	Pressure Equipment Directive	PED 2014/68/EU
	Pressure Accessories	Scope: Article 1, section 1 Definition: Article 2, section 5
	Fluid group 2:	
	≤ DN 40	without CE-marking, as per article 4, section 3 (sound engineering practice) ³⁾
	DN 50...100	Category I, Module A, with CE-marking, as per article 14, section 2
	DN 125...150	Category II, Module A2, with CE-marking, as per article 14, section 2 notified body number 0036
	DN 200, DN 250	Category II, Module A2, with CE-marking, as per article 14, section 2 notified body number 0035
	EU Conformity (CE)	
	DN 50...150	A5W00006523 ⁴⁾
	DN 200, DN 250	A5W90001026 ⁴⁾
PN class	ISO 7268	
Operating pressure	ISO 7005, DIN EN 12284	
Flanges	ISO 7005	
Length of flanged valves	DIN EN 558-1, line 1	

	Valve characteristic	VDI 2173	
	Leakage rate	Throughport, Bypass according to EN 60534-4 / EN 1349	
	Water treatment	VDI 2035	
Environmental conditions	Storage: IEC 60721-3-1	Class	1K3
		Temperature	-15...55 °C
		Rel. humidity	5...95 % r.h.
	Transport: IEC 60721-3-2	Class	2K3, 2M2
		Temperature	-30...65 °C
		Rel. humidity	< 95 % r.H.
	Operation: IEC 60721-3-3	Class	3K5, 3Z11
		Temperature	-15...55 °C
		Rel. humidity	5...95 % r.h.
Environmental compatibility	The product environmental declaration CE1E4405en01 ⁴⁾ , CE1E4405en02 ⁴⁾ , CE1E4404en02 ⁴⁾ and A5W90001031 ⁴⁾ contains data on environmentally compatible product design and assessments (RoHS compliance, materials composition, packaging, environmental benefit, disposal).		
Dimensions / Weight	Dimensions	See „Dimensions“, page 15 + 16	
	Weight	See „Dimensions“, page 15 + 16	

- ¹⁾ For certain valve lines and high k_{vs} values, the valve characteristic is optimized for maximum volumetric flow k_{V100}
- ²⁾ With SAX.. and SAV...: Usable up to a max. medium temperature of 130 °C
With SKD...: Usable up to a max. medium temperature of 150 °C
For medium temperatures < -5 °C, the stem sealing gland must be replaced, please see page 4.
- ³⁾ Valves where $PS \times DN < 1000$, do not require special testing and cannot carry the CE label.
- ⁴⁾ The documents can be downloaded from <http://www.siemens.com/bt/download>

Dimensions

VVF53..

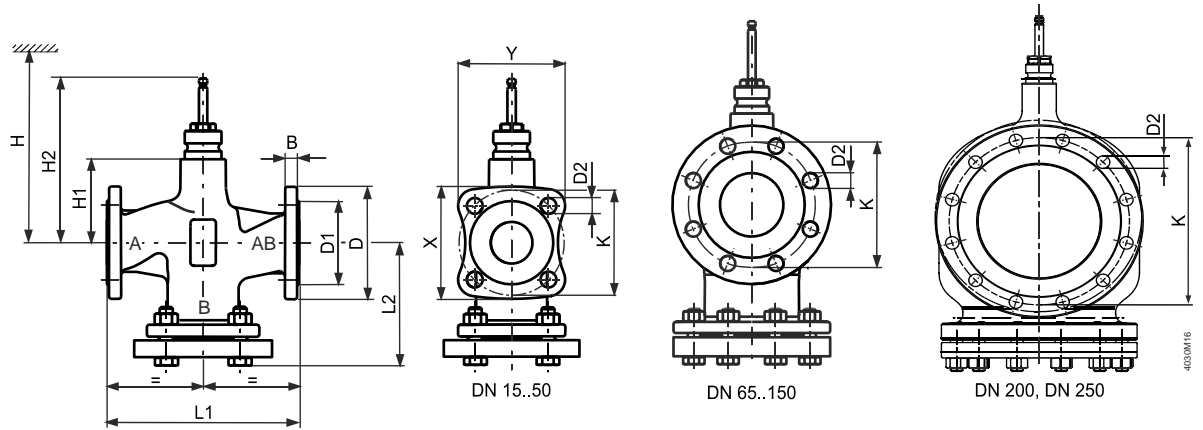

Product number	DN	kg	B	Ø D	Ø D1	Ø D2	L1	L2	X	Y	Ø K	H1	H2	H				
														SAX..	SKD..	SKB..	SAV..	SKC..
VVF53..	15	4.2	14	95	46	14 (4x)	130	87.5	79	76	65	63	159.5	505	563	638	-	-
	20	5.3	16	105	56	14 (4x)	150	99.5	86.6	83	75	63	144.4	505	563	638	-	-
	25	6.1	15	115	65	14 (4x)	160	104.5	94.4	90.1	85	63	159.5	505	563	638	-	-
	32	8.7	17	140	76	19 (4x)	180	119	115.6	110.7	100	60	156.5	502	560	635	-	-
	40	10.1	16	150	84	19 (4x)	200	129	123.2	117.8	110	60	156.5	502	560	635	525	-
	50	13.6	16	165	99	19 (4x)	230	146	135.2	128.4	125	100	196.5	542	600	675	565	-
	65	22	17	185	118	19 (8x)	290	178	-	-	145	115	231.5	-	-	-	580	690
	80	27.4	17	200	132	19 (8x)	310	190	-	-	160	115	231.5	-	-	-	580	690
	100	38.2	17	235	156	23 (8x)	350	212.5	-	-	190	146	262.5	-	-	-	611	721
	125	53.1	17	270	184	28 (8x)	400	242	-	-	220	159	275.5	-	-	-	624	734
VVF53..K	150	73.4	17	297	211	28 (8x)	480	284	-	-	250	186.5	303	-	-	-	652	762
	50	13.6	16	165	99	19 (4x)	230	146	135.2	128.4	125	100	196.5	-	600	675	-	-
	65	22	17	185	118	19 (8x)	290	178	-	-	145	115	231.5	-	-	-	-	690
	80	27.6	17	200	132	19 (8x)	310	190	-	-	160	115	231.5	-	-	-	-	690
	100	38.6	17	235	156	23 (8x)	350	212.5	-	-	190	146	262.5	-	-	-	-	721
	125	53.8	17	270	184	28 (8x)	400	242	-	-	220	159	275.5	-	-	-	-	734
	150	75	17	297	211	28 (8x)	480	284	-	-	250	186.5	303	-	-	-	-	762
	200	133	30	360	274	26 (12x)	600	265	-	-	310	243	359.5	-	-	-	-	818
	250	200	32	425	330	30 (12x)	730	290	-	-	370	275	391.5	-	-	-	-	850

VXF53..

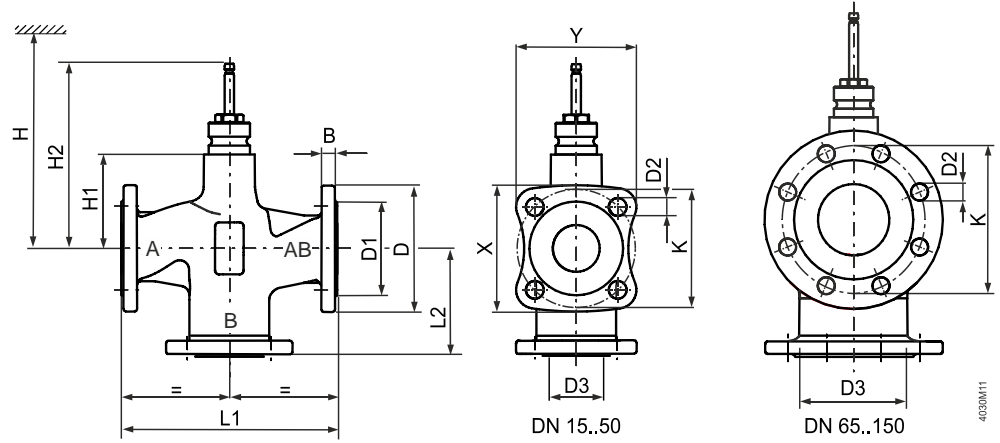





Product number	DN	K ₀	B	Ø D	Ø D1	Ø D2	Ø D3 ¹⁾	L1	L2	X	Y	Ø K	H1	H2	H				
															SAX..	SKD..	SKB..	SAV..	SKC..
VXF53..	15	3.2	14	95	46	14 (4x)	25	130	65	79	76	65	63	159.5	505	563	638	-	-
	20	4.0	16	105	56	14 (4x)	35	150	75	86.6	83	75	63	159.5	505	563	638	-	-
	25	4.6	15	115	65	14 (4x)	38	160	80	94.4	90.1	85	63	159.5	505	563	638	-	-
	32	6.1	17	140	76	19 (4x)	46	180	90	115.6	110.7	100	60	156.5	502	560	635	-	-
	40	7.2	16	150	84	19 (4x)	57	200	100	123.2	117.8	110	60	156.5	502	560	635	525	-
	50	9.7	16	165	99	19 (4x)	69	230	115	135.2	128.4	125	100	196.5	542	600	675	565	-
	65	16.3	17	185	118	19 (8x)	86	290	145	-	-	145	115	231.5	-	-	-	580	690
	80	20.6	17	200	132	19 (8x)	100	310	155	-	-	160	115	231.5	-	-	-	580	690
	100	28.1	17	235	156	23 (8x)	123	350	175	-	-	190	146	262.5	-	-	-	611	721
	125	38.5	17	270	184	28 (8x)	149	400	200	-	-	220	159	275.5	-	-	-	624	734
	150	54.9	17	297	211	28 (8x)	174	480	240	-	-	250	186.5	303	-	-	-	652	762

¹⁾ Interior opening of the bypass port

Spare parts

Stem sealing gland

Product number	DN	Stock number	Comments	
VVF53.. VXF53.. VVF53..K	DN 15...50 and DN 65...150 Series A, B and C	74 284 0061 0	Standard version with FEPM-O-ring for medium temperatures between -5 °C and 220 °C.	
VVF53.. VXF53.. VVF53..K	DN 65...150 As from series D	S55846-Z114	Standard version with FEPM-O-ring for medium temperatures between -5 °C and 220 °C.	
VVF53.. K	DN 200, DN 250	4 679 5630 0	Standard version with PTFE sleeve for medium temperatures between -5 °C and 220 °C	
VVF53.. VXF53..	DN 15...50	4 284 8806 0	When operating with medium temperatures below -5 °C. With the gland 428488060 the valve can be used with water, water with antifreeze and brines between -20 °C and 150 °C.	
VVF53.. VXF53..	DN 65...150	4 679 5629 0	When operating with medium temperatures below -5 °C. With the gland 467956290 the valve can be used with water, water with antifreeze and brines between -20 °C and 150 °C.	
VVF53..	DN 65...150	4 679 5629 0	When operating with medium temperatures below -5 °C. With the gland 467956290 the valve can be used with water, water with antifreeze and brines between -20 °C and 150 °C.	
VXF53..	DN 15...50	4 284 8806 0	When operating with medium temperatures below -5 °C. With the gland 467956290 the valve can be used with water, water with antifreeze and brines between -20 °C and 150 °C..	
VVF53.. VVF53..K	DN 15...150 and DN65... 150 series A, B and C	74 284 0061 0	Standard version with FEPM-O-ring for medium temperatures between -5 °C and 220 °C.	
VVF53.. VVF53..K	DN 65...150 As from series D	S55846-Z114	Standard version with FEPM-O-ring for medium temperatures between -5 °C and 220 °C.	
VVF53..K	DN 200, DN 250	4 679 5630 0	Standard version with FEPM-O-ring for medium temperatures between -5 °C and 220 °C.	

Revision numbers

Product number	Valid from rev. no.	Product number	Valid from rev. no.	Product number	Valid from rev. no.
VVF53.15-0.16	..A	VVF53.50-40K	..D	VXF53.15-1.6	..A
VVF53.15-0.2	..A	VVF53.65-63K	..D	VXF53.15-2.5	..A
VVF53.15-0.25	..A	VVF53.80-100K	..D	VXF53.15-4	..A
VVF53.15-0.32	..A	VVF53.100-150K	..D	VXF53.20-6.3	..A
VVF53.15-0.4	..A	VVF53.125-220K	..D	VXF53.25-6.3	..A
VVF53.15-0.5	..A	VVF53.150-315K	..D	VXF53.25-10	..A
VVF53.15-0.63	..A	VVF53.200-450K	..A	VXF53.32-16	..A
VVF53.15-0.8	..A	VVF53.250-630K	..A	VXF53.40-16	..A
VVF53.15-1	..A			VXF53.40-25	..A
VVF53.15-1.25	..A			VXF53.50-40	..B
VVF53.15-1.6	..A			VXF53.65-63	..D
VVF53.15-2	..A			VXF53.80-100	..D
VVF53.15-2.5	..A			VXF53.100-160	..D
VVF53.15-3.2	..A			VXF53.125-250	..D
VVF53.15-4	..A			VXF53.150-400	..D
VVF53.20-6.3	..A				
VVF53.25-5	..A				
VVF53.25-6.3	..A				
VVF53.25-8	..A				
VVF53.25-10	..A				
VVF53.32-16	..A				
VVF53.40-12.5	..A				
VVF53.40-16	..A				
VVF53.40-20	..A				
VVF53.40-25	..A				
VVF53.50-31.5	..B				
VVF53.50-40	..B				
VVF53.65-63	..D				
VVF53.80-100	..D				
VVF53.100-160	..D				
VVF53.125-250	..D				
VVF53.150-400	..D				

Issued by
Siemens Switzerland Ltd
Smart Infrastructure
Global Headquarters
Theilerstrasse 1a
6300 Zug
Switzerland
Tel. +41 58-724 24 24
www.siemens.com/buildingtechnologies

© Siemens Switzerland Ltd, 2011
Technical specifications and availability subject to change without notice.