



QRC1... for frontal illumination



QRC1... for lateral illumination

Blue-flame Detectors

QRC1...

Blue-flame detectors for the supervision of blue- or yellow-burning oil or gas flames. Blue-flame detectors are used primarily in connection with burner controls for small-capacity burners in intermittent operation.

The QRC1... and this Data Sheet are intended for use by OEMs which integrate the flame detectors in their products!

Use

The QRC1... is a compact UV-sensitive blue-flame detector with an integrated preamplifier. It is designed for frontal and lateral (90°) illumination.

QRC1... is suited for use with following burner controls and with photoresistive detectors QRB1... - in terms of plug-in facility:

- LAL1... see Data Sheet N7153
- LGB3... see Data Sheet N7435
- LME23... see Data Sheet N7101
- LMO14..., LMO24..., LMO44... see Data Sheet N7130
- LMO54... see Data Sheet N7137
- LMV26... see Data Sheet N7547
- LMV27... see Data Sheet N7541
- LMV36... see Data Sheet N7544
- LMV37... see Data Sheet N7546
- LOA2... (except LOA25...), LOA3... see Data Sheet N7118

The spectral sensitivity of the QRC1... is a maximum of approximately 300 nm so that it optimally covers the range of UV radiation of blue-burning oil or gas flames.

Since the QRC1... also detects UV fractions of the radiation spectrum of other luminous sources (from boiler house illumination or sunlight etc.), the standard regulations for extraneous light still apply.

The QRC1... must not detect UV radiation from ignition sparks, as otherwise lockout occurs during the prepurge time, due to extraneous light.

Warning notes



To avoid injury to persons, damage to property or the environment, the following warning notes must be observed!

Do not open, interfere with or modify the flame detector!

- All activities (mounting, installation and service work, etc.) must be performed by qualified staff
- Before making any wiring changes in the connection area, completely isolate the plant from mains supply (all-polar disconnection). Ensure that the plant cannot be inadvertently switched on again and that it is indeed dead. If not observed, there is a risk of electric shock hazard
- Ensure protection against electric shock hazard by providing adequate protection for the connection terminals. If not observed, there is a risk of electric shock hazard
- Each time work has been carried out (mounting, installation, service work, etc.), check to ensure that wiring is in an orderly state and make the safety checks as described in *Commissioning notes*. If not observed, there is a risk of impairment of safety functions and of electric shock hazard
- Fall or shock can adversely affect the safety functions. Such detectors must not be put into operation, even if they do not exhibit any damage. If not observed, there is a risk of impairment of safety functions and of electric shock hazard

Mounting notes

- Ensure that the relevant national safety regulations are complied with
- Locate the ignition electrode such that the QRC1... cannot detect ignition sparks, as otherwise lockout occurs due to extraneous light
- Fit the flame detector with the help of a plug inserted in a hole on the burner. For hole on the burner, see Dimensions.
The securing and sealing lips of the plug give the QRC1... a firm hold in the hole, even in the case of vibrations, also allowing the QRC1... to be removed for maintenance work
- Locate the QRC1... such that it can detect the most radiation-active zone of the flame
- For the precise adjustment of the distance between the most radiation-active range of the flame and the converging lens of the UV-sensitive diode, the QRC1... can be displaced in its plug by about 10 mm in both longitudinal directions **S** (snap-in) (see Dimensions)

Installation notes

- Always run the detector cables separately while observing the greatest possible distances from other cables and units
- It is important to achieve practically disturbance- and loss-free signal transmission:
 - Line capacitance reduces the magnitude of the flame signal
 - Use a separate cable
- Observe the permissible length of the detector cable (see Technical data)

Commissioning notes

- Information's of measuring circuit an the required detector current values, see Data Sheet of the accordant burner control
- Information's about the safety checks to be carried out, see Data Sheet of the accordant burner control

Standards and certificates



Note!
Only in connection with burner controls!



EAC Conformity mark (Eurasian Conformity mark)



ISO 9001:2008
ISO 14001:2004
OHSAS 18001:2007

Service notes

- When cleaning the detector, always use a clean cloth
- Do not use any burner cleansing sprays

Disposal notes



The detector contains electrical and electronic components and must not be disposed of together with household waste. Local and currently valid legislation must be observed.

Mechanical design

The housing is made of black plastic and has a displaceable plug with stops. The 3-core connecting cable is firmly connected to the QRC1... and features strain relief. The front of the detector has a protective glass to ensure protection against accidental contact, dust and hermetic tightness.

QRC1... with mirror fixture

In the case of burner designs that do not allow the QRC1... to be illuminated from the front, the QRC1... is also available with a mirror attachment for lateral illumination.

Type summary (other types on request)

When ordering, please give type reference according to *Standard types* or *Type summary*.

Type reference	Mains voltage (50/60 Hz)	Cable length L (see Dimensions) (mm)	Cable sheath stripped M (see Dimensions) (mm)	Plug	Class of sensitivity	Direction of illumination	Viewing window	End of cable		
								Strain relief AGK...	Plug AGK...	Ferrule
QRC1A1.101C27	AC 230 V	350	70	with	Normal	Frontal	Plexiglas	---	---	●
QRC1A1.103C27	AC 230 V	500	70	with	Normal	Frontal	Plexiglas	---	---	●
QRC1A1.170C27	AC 230 V	130	---	with	Normal	Frontal	Plexiglas	---	53.0	---
QRC1A1.181C27	AC 230 V	240	---	with	Normal	Frontal	Plexiglas	---	56.38	---
QRC1A1.1013C27	AC 230 V	350	70	with	Normal	Frontal	Fused quartz	---	---	●
QRC1A1.1623C27	AC 230 V	270	---	with	Normal	Frontal	Fused quartz	---	53.2	---
QRC1AA.1623C27	AC 230 V	270	---	with	Normal *)	Frontal	Fused quartz	---	53.2	---
QRC1A2.103C27	AC 230 V	500	70	with	Middle	Frontal	Plexiglas	---	---	●
QRC1A2.104C27	AC 230 V	700	70	with	Middle	Frontal	Plexiglas	---	---	●
QRC1A2.1063C27	AC 230 V	270	40	with	Middle	Frontal	Fused quartz	---	---	---
QRC1A3.101C27	AC 230 V	350	70	with	High	Frontal	Plexiglas	---	---	●
QRC1A3.103C27	AC 230 V	500	70	with	High	Frontal	Plexiglas	---	---	●
QRC1A3.1013C27	AC 230 V	350	70	with	High	Frontal	Fused quartz	---	---	●
QRC1C0.182C27	AC 230 V	270	---	with	Normal	Lateral	Plexiglas	68.733	56.38	---
QRC1C2.103C27	AC 230 V	500	70	with	Middle	Lateral	Plexiglas	---	---	●

*) Tolerance band is constricted

Technical data

General detector data	Mains voltage	AC 230 V –15/+10%	
	Mains frequency	50 / 60 Hz ±6%	
	Power consumption	0.35 VA	
	Tolerated flame signal interruptions	Approx. 300 ms	
	Length of connecting cable	Max. 1 m	
	Length of auxiliary detector cable	Max. 20 m (only in case of separate cable runs, see Maximum detector cable length)	
	Detector cable	Internal conductor 3 x 0.5 mm ² ; copper wire sheath 5.45 mm dia., PVC	
	Degree of protection	IP40	
	Safety class	II	
	Vibrations to IEC 68-2-6	Max. 1 g, 10...500 Hz	
	Weight incl. 350 mm cable	Approx. 0.029 kg	
	Mounting position	Optional	
	Environmental conditions	Storage	DIN EN 60721-3-1
		Climatic conditions	Class 1K3
Mechanical conditions		Class 1M2	
Temperature range		-20...+60 °C	
Humidity		<95% r.h.	
Transport		DIN EN 60721-3-2	
Climatic conditions		Class 2K2	
Mechanical conditions		Class 2M2	
Temperature range		-25...+80 °C	
Humidity		<95% r.h.	
Operation		DIN EN 60721-3-3	
Climatic conditions		Class 3K5	
Mechanical conditions		Class 3M2	
Temperature range		-20...+60 °C short-time (max. 1 min) up to 75 °C	
Humidity	<95% r.h.		



Caution!

**Condensation, formation of ice and ingress of water are not permitted!
If not observed, the safety functions are no longer ensured and there will be a
risk of electric shock!**

Function

The QRC1... has a special UV-sensitive diode with a quartz-glass lens which concentrates the flame's radiation on the active part of the diode. A filter ensures that fractions of radiation of longer wave lengths will be eliminated. A preamplifier is used to amplify the signal of the diode to the level required for the flame signal amplifier of the respective burner control.

Flame signal interruptions of short duration are tolerated (see Technical data - Tolerated flame signal interruptions), thus ensuring more stable detector currents and more stable operation of the burner in the event of strongly flickering flames.

Maximum detector cable length

If the maximum cable length of 1 m is not sufficient, the burner manufacturer can extend the cable by a maximum of 20 m.

In that case, the following rule must be observed when laying the cable:

To minimize the coupling capacitances of the detector signal lines to the live conductor, live conductor (L) (brown core) must be laid separately or segregated from the detector signal line.

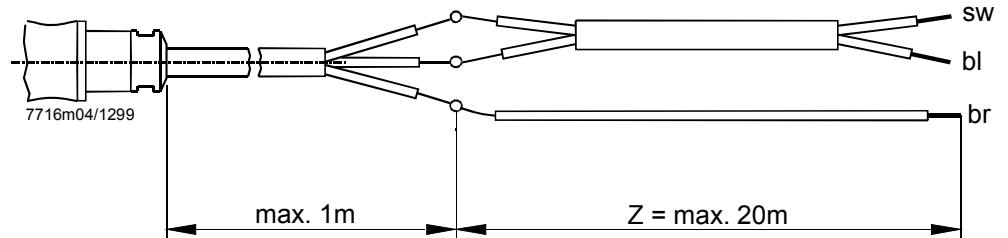

Legend

- Z Auxiliary cable
- bl Blue core = neutral conductor (N)
- br Brown core = live (L)
- sw Black core = signal line

Spectral curves

Extraneous light

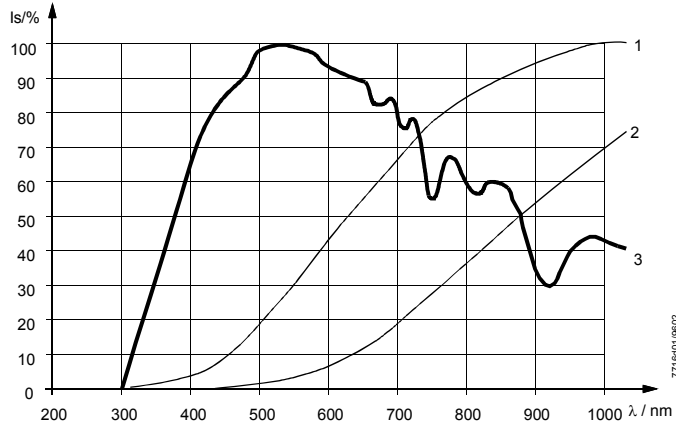

Flames

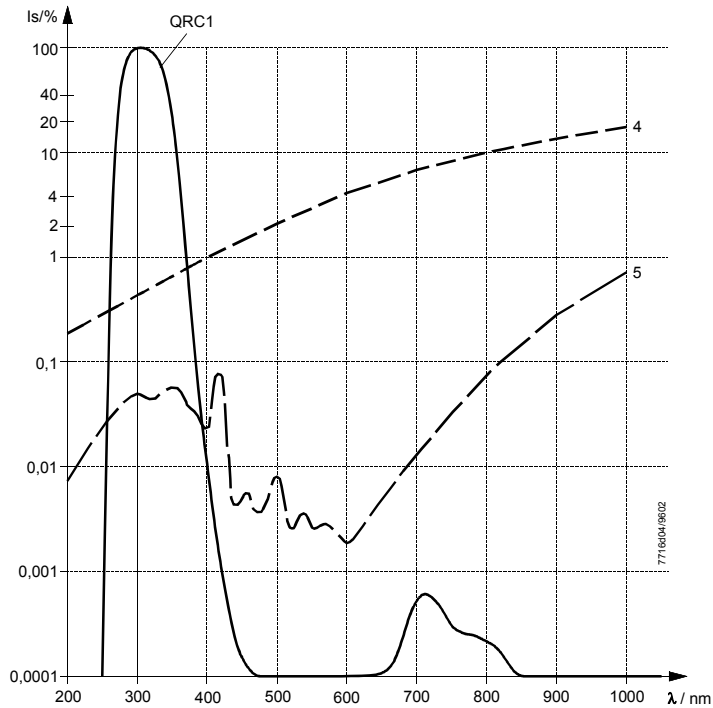

Sensitivity of light detector

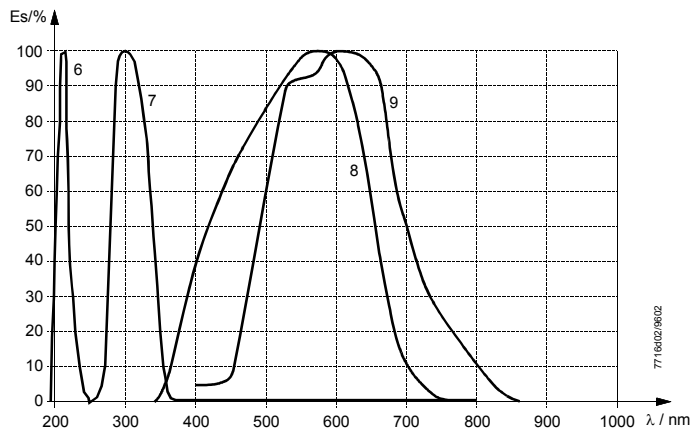

Legend

Is/% ES/%	Relative intensity of radiation in percent Spectral sensitivity in percent	λ/nm QRC1...	Wave length in nm Spectral sensitivity of QRC1...
1	2856 K-radiation	6	UV photocell
2	2000 K-radiation	7	QRC1... photo diode
3	Solar radiation	8	Selenium cell
4	yellow burning oil flame	9	QRB... photo resistance
5	blue burning oil flame		

Dimensions

Dimensions in mm

Frontal illumination

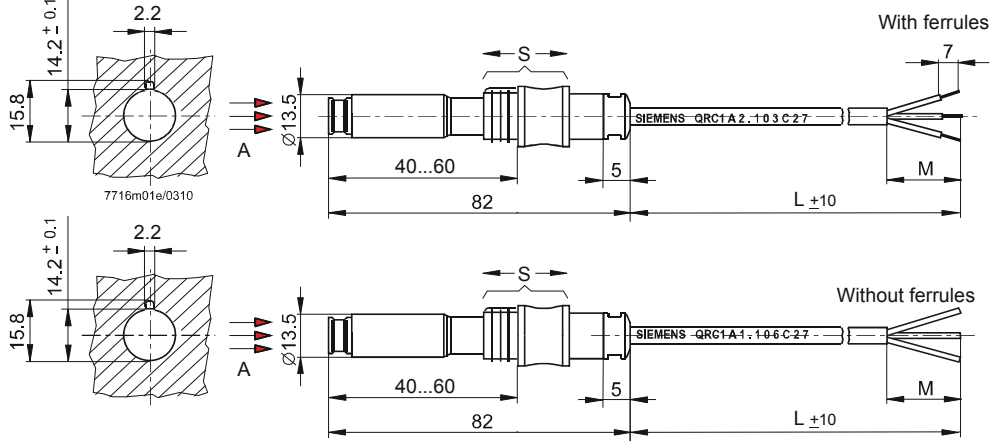

Lateral illumination

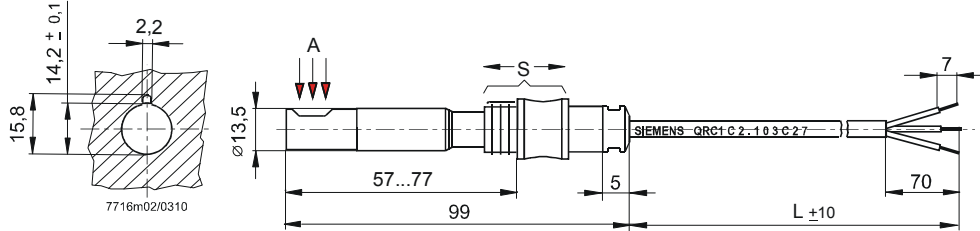

QRC... with plug AGK53.0

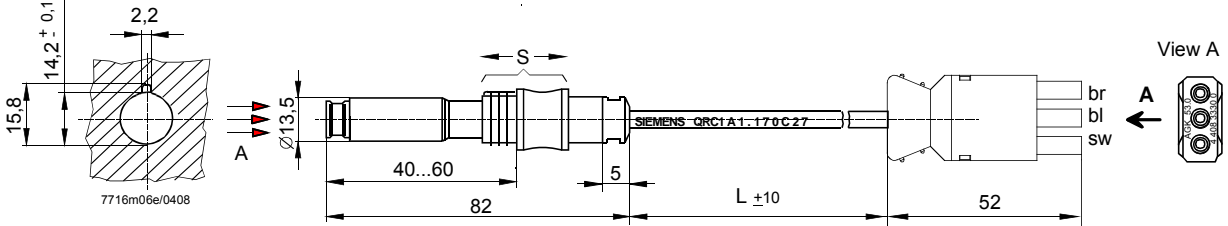

QRC... with plug AGK53.2

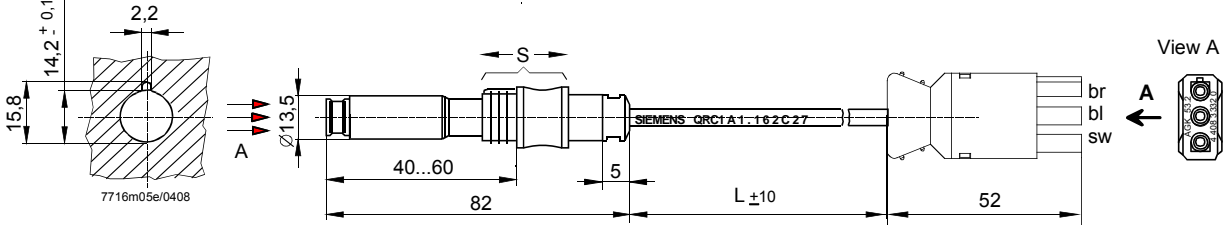

QRC... with plug AGK56.38 and strain relief AGK68.733

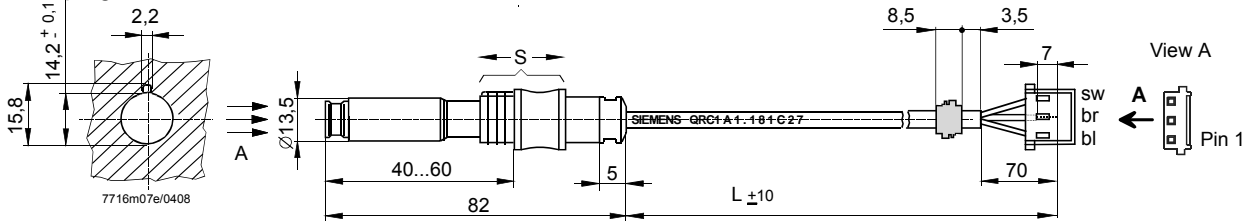

Legend

A	Incidence of illumination	bl	blue
L	Available cable length (see Type summary)	br	brown
M	Cable sheath stripped, see Type summary	sw	black
S	Range of displacement of plug produces a change in the dimensions ...		
	...40...60 mm (front)		50 mm as supplied
	...57...77 mm (side)		67 mm as supplied