



OpenAir™

Air damper actuators

GMA..1

Rotary version with spring return, AC 24 V / DC 24...48 V / AC 230 V

Electronic motor driven actuators for two-position, three-position, and modulating control, nominal torque 7 Nm, with spring return, self-centering shaft adapter, mechanically adjustable span between 0...90°, prewired with 0.9 m long connection cables.

Type-specific variations with adjustable offset and span for the positioning signal, position indicator, feedback potentiometer and adjustable auxiliary switches for supplementary functions.

Remarks

This data sheet provides a brief overview of these actuators. Please refer to the technical basics in CM2Z4614en for a detailed description as well as information on safety, engineering notes, mounting and commissioning.

Use

- For damper areas up to 1.5 m², friction-dependent.
- In ventilation sections where the actuator must move to the zero position (emergency position) during power failure.
- For dampers having two actuators on the same damper shaft (tandem-mounted actuators or Powerpack).

Type summary

GMA...	121.1E	126.1E	321.1E	326.1E	131.1E	132.1E ¹⁾	136.1E	161.1E	163.1E	164.1E	166.1E
Control type	Two-position control				Three-position control			Modulating control			
Operating voltage AC 24 V DC 24...48 V	X	X			X	X	X	X	X	X	X
Operating voltage AC 230 V			X	X							
Positioning signal Y DC 0...10 V DC 0...35 V with characteristic function $U_o, \Delta U$								X			X
Position indicator $U = DC 0...10 V$								X	X	X	X
Feedback potentiometer 1k Ω						X					
Auxiliary switches (two)		X		X			X			X	X
Powerpack (2 actuators)	X	X	X	X	X	X	X				

¹⁾ While stocks last

Functions

Type	GMA12..1 / GMA32..1	GMA13..1	GMA16..1
Control type	Two-position control	Three-position control	Modulating control
Positioning signal with adjustable characteristic function			DC 0...35 V at Offset $U_o = 0...5 V$ Span $\Delta U = 2...30 V$
Rotary direction	Clockwise or counter-clockwise movement depends on the mounting position of the damper shaft... ...and on the type of control.		
Spring return	On power failure or when the operating voltage is switched off, the spring return moves the actuator to its mechanical zero position.		
Position indication: Mechanical	Rotary angle position indication by using a position indicator.		
Position indication: Electrical		The feedback potentiometer can be connected to external voltage to indicate the position.	Output voltage $U = DC 0...10 V$ is generated proportional to the rotary angle.
Auxiliary switch	The switching points for auxiliary switches A and B can be set independent of each other in increments of 5° within 5° to 90°.		
Powerpack (two actuators, tandem-mounted)	Mounting two of the same actuator types on the same damper shaft may result in a double torque.	Is not permitted	
Rotary angle limitation	The rotational angle of the shaft adapter can be limited mechanically at increments of 5°.		

Ordering



Note	The potentiometer cannot be added in the field . For this reason, order the type that includes this option.
Delivery	Individual parts such as position indicator and other mounting materials for the actuator are not mounted on delivery.
Accessories, spare parts	Accessories to functionally extend the actuators are available, e.g. external auxiliary switch, linear/rotary sets and weather protection cover; see data sheet N4697 .

Disposal

The document on technical basics and the environmental declaration provide information on environmental compatibility and disposal of this device.

 Caution
<p>National safety regulations</p> <p>Failure to comply with national safety regulations may result in personal injury and property damage.</p> <ul style="list-style-type: none"> • Observe national provisions and comply with the appropriate safety regulations. • Use only properly trained technicians for mounting, commissioning, and servicing.

Technical data

 AC 24 V DC 24...48 V supply (SELV/PELV)	Operating voltage AC / Frequency	AC 24 V ± 20 % / 50/60 Hz
	Operating voltage (DC)	DC 24...48 V ±20 %
	Power consumption	GMA1..1: Running AC: 5 VA / 3.5 W // DC: 3.5 W GMA12..1, 13..1: Holding AC/DC: 2 W GMA16..1,: Holding AC/DC: 2.5 W
 AC 230 V supply	Operating voltage / Frequency	AC 230 V ± 10 % / 50/ 60 Hz
	Power consumption	GMA32..1: Running 7 VA / 4.5 W Holding 3.5 W
Function data	Nominal torque	7 Nm
	Maximum torque (blocked)	21 Nm
	Nominal rotary angle / Max. rotary angle	90° / 95° ± 2°
	Runtime for rotary angle 90° (motor operation)	90 s
	Closing time with return spring (on power failure)	15 s
Positioning signal for GMA13..1	Switching current (at AC 24 V / DC 24...48 V) for "Open"/"Close" (cores 6,7)	normally 8 mA
Positioning signal for GMA16..1	Input voltage Y (wires 8-2)	DC 0...10 V / DC 2...10 V
	Max. permissible input voltage	DC 35 V
Characteristic functions for GMA161.1, 166.1 for GMA163.1, 164.1	Input voltage Y (wires 8-2)	DC 0...35 V
	Non-adjustable characteristic function	DC 0...10 V / DC 2...10 V
	Adjustable characteristic function	
	Offset U _o	DC 0...5 V
Position indicator for GMA16..1	Span ΔU	DC 2...30 V
	Output voltage U (cores 9-2)	DC 0...10 V
	Max. output current	DC ± 1 mA
Feedback potentiometer for GMA132.1	Change of resistance (wires P1-P2)	0...1000 Ω
	Load	< 1 W

! Auxiliary switch
for GMA..6.1, 164.1

	AC power supply	
	Switching voltage	AC 24...230 V
	Nominal current res./ind.	6 A / 2 A
	DC power supply	
	Switching voltage	DC 12..30 V
	Nominal current	DC 2 A
	Switching range for auxiliary switches / Setting increments	5°...90° / 5°
Connection cables	Cross-section	0.75 mm ²
	Standard length	0.9 m
Degree of protection of housing	Degree of protection as per EN 60 529 (note mounting instructions) IP 54	
Protection class	Insulation class	EN 60 730
	AC/DC 24 V, feedback potentiometer	III
	AC 230 V, auxiliary switch	II
Environmental conditions	Operation / Transport	IEC 721-3-3 / IEC 721-3-2
	Temperature	-32...+55 °C / -32...+70 °C
	Humidity (non-condensing)	< 95% r. h. / < 95% r. h.
Standards and directives	Product safety: Automatic electrical controls for household and similar use	EN 60 730-2-14 (Type 1)
	Electromagnetic compatibility (Application)	For residential, commercial and industrial environments
	EU Conformity (CE)	8000081792 ¹⁾
	RCM Conformity	8000081793 ¹⁾
	Product environmental declaration ²⁾	CE1E4614en ¹⁾
Dimensions	Actuator W x H x D (see "Dimensions")	81 x 192 x 63 mm
	Damper shaft: Round / square	6.4...20.5 / 6.4...13 mm
	Min. shaft length	20 mm
Weight	Without packaging: GMA1..1 / GMA32..1	1.2 kg / 1.3 kg

¹⁾ The documents can be downloaded from <http://siemens.com/bt/download>

²⁾ The product environmental declaration contains data on environmentally compatible product design and assessments (RoHS compliance, materials composition, packaging, environmental benefit, disposal).

Disposal

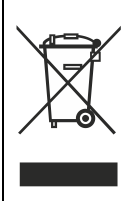
	<p>The device is considered an electronics device for disposal in terms of European Directive 2012/19/EU and may not be disposed of as domestic garbage.</p> <ul style="list-style-type: none"> ● Dispose of the device through channels provided for this purpose. ● Comply with all local and currently applicable laws and regulations.
---	--

Internal diagrams

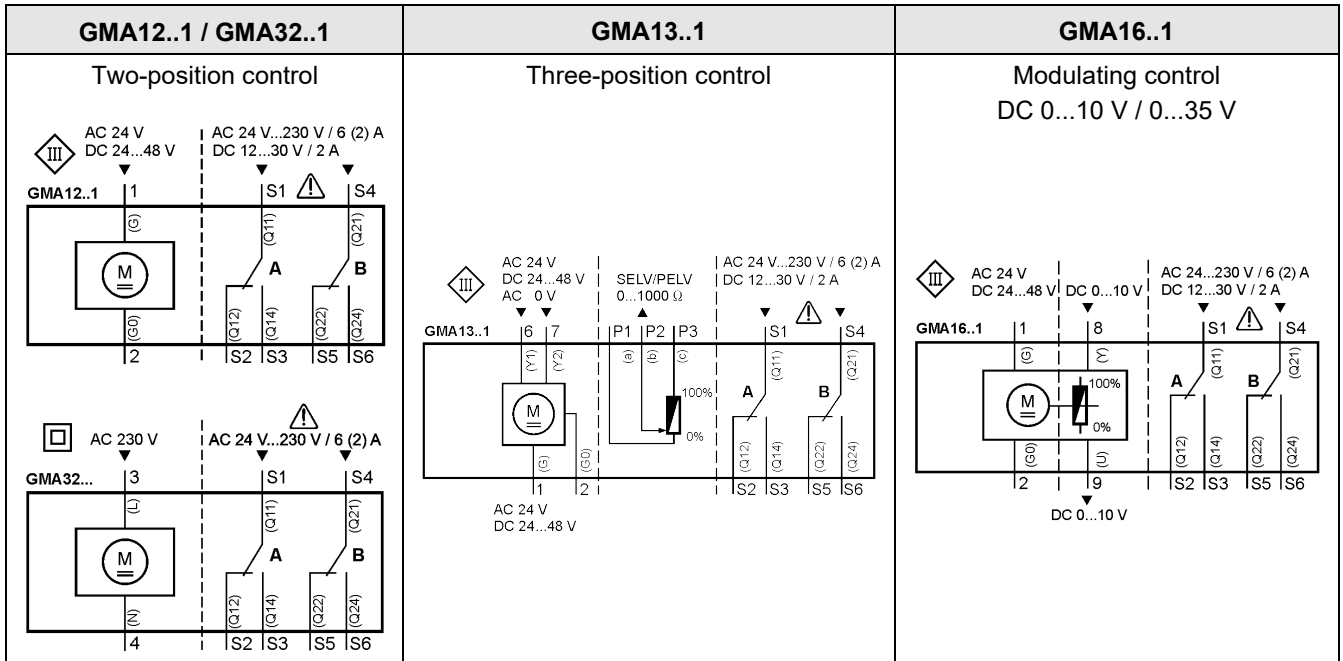

Connection diagrams

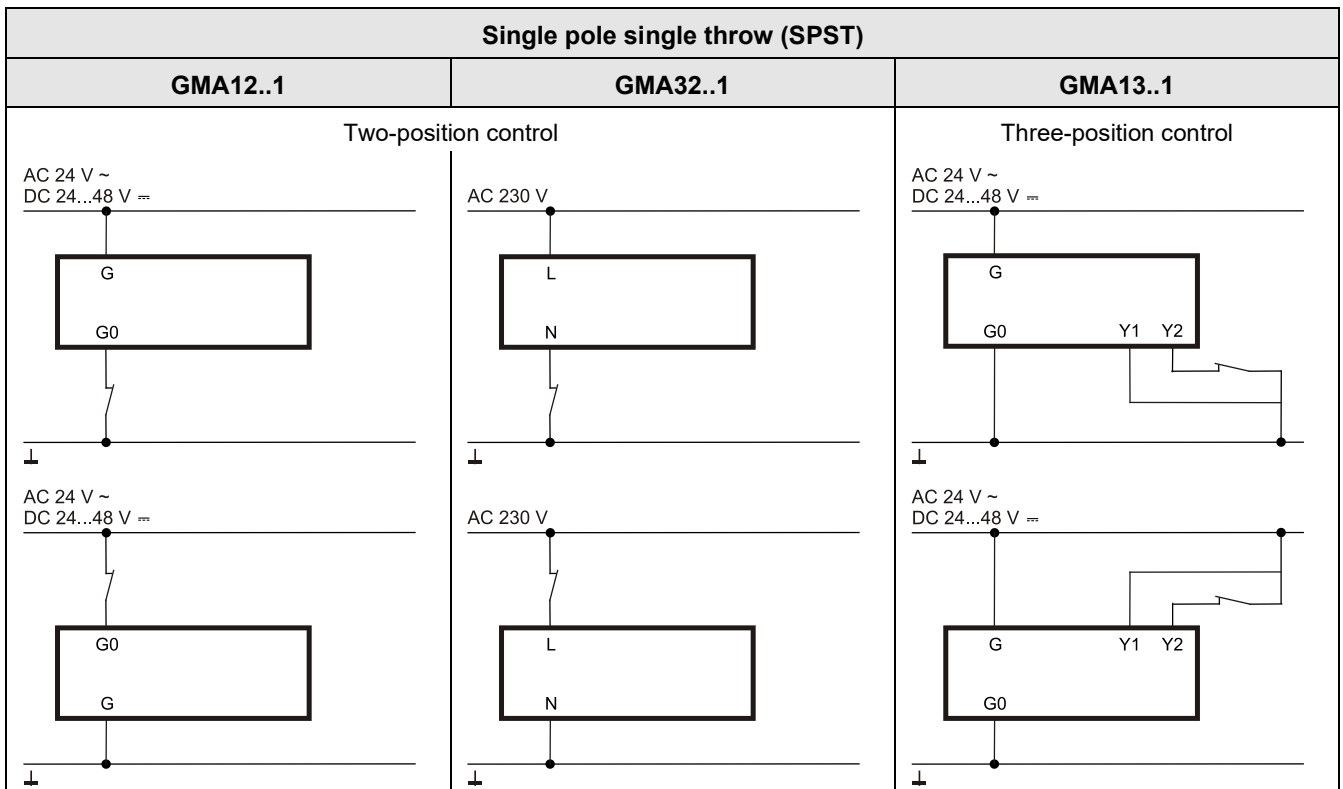

Cable labeling

Pin	Cable				Meaning
	Code	No.	Color	Abbreviation	
Actuators AC 24 V DC 24...48 V	G	1	red	RD	System potential AC 24 V/DC 24...48 V
	G0	2	black	BK	System neutral
	Y1	6	purple	VT	Pos. signal AC 0 V/AC 24 V/DC 24...48 V, "open"
	Y2	7	orange	OG	Pos. signal AC 0 V/AC 24 V/DC 24...48 V, "close"
	Y	8	grey	GY	Pos. signal DC 0...10 V, 0...35 V
	U	9	pink	PK	Position indication DC 0...10 V
Actuators AC 230 V	L	3	brown	BN	Phase AC 230 V
	N	4	blue	BU	Neutral conductor
Auxiliary switch	Q11	S1	grey/red	GY RD	Switch A input
	Q12	S2	grey/blue	GY BU	Switch A normally-closed contact
	Q14	S3	grey/pink	GY PK	Switch A normally-open contact
	Q21	S4	black/red	BK RD	Switch B input
	Q22	S5	black/blue	BK BU	Switch B normally-closed contact
	Q24	S6	black/pink	BK PK	Switch B normally-open contact
Feedback potentiometer	a	P1	white/red	WH RD	Potentiometer 0...100 % (P1-P2)
	b	P2	white/blue	WH BU	Potentiometer pick-off
	c	P3	white/pink	WH PK	Potentiometer 100...0 % (P3-P2)

Dimensions

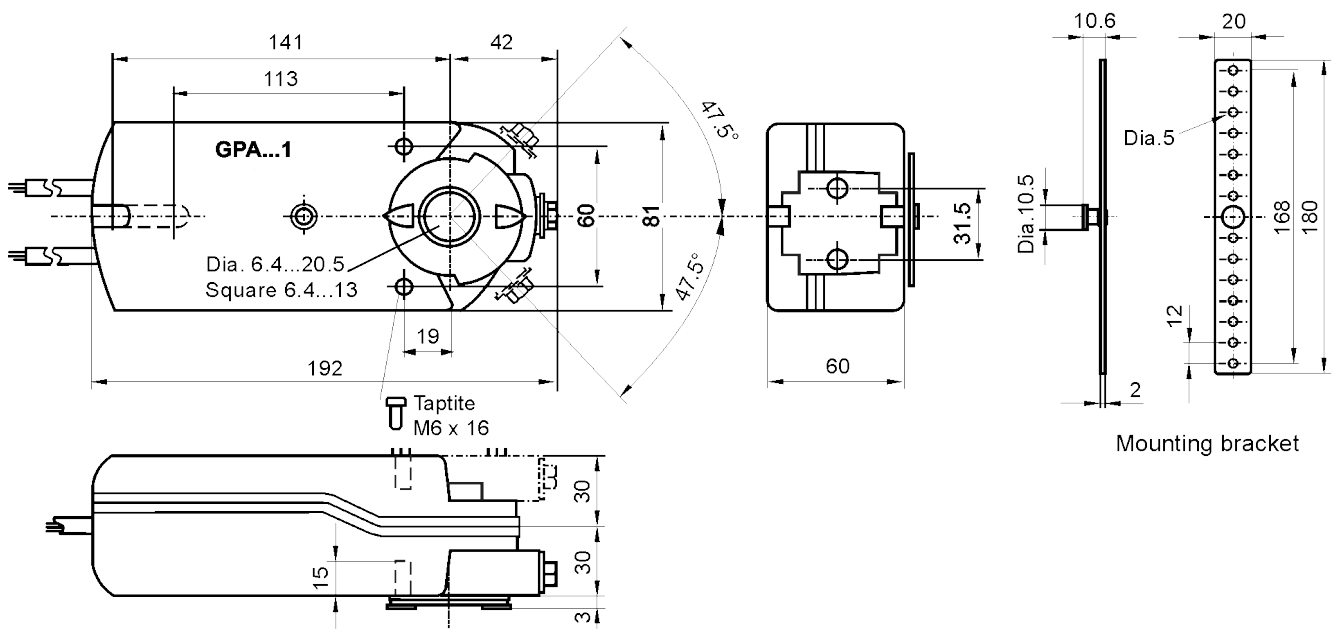

Dimensions in mm

Issued by
Siemens Switzerland Ltd
Smart Infrastructure
Global Headquarters
Theilerstrasse 1a
6300 Zug
Switzerland
Tel. +41 58-724 24 24

www.siemens.com/buildingtechnologies

© Siemens Switzerland Ltd, 2004

Technical specifications and availability subject to change without notice.