

Analog Input Modules

AGA56...

Analog input modules for the control of SQM5 air damper actuators by continuous analog control signals, such as 4...20 mA, and continuous analog position feedback signals.

For supplementary Data Sheets, refer to SQM5 Data Sheet N7815 and ASZ Data Sheet N7921.

AGA56 and this Data Sheet are intended for use by OEMs which integrate the modules in their products!

Use

The AGA56s are extension modules for use with the SQM5 actuator. They can be mounted into the SQM5 actuators on site or else supplied already built in.

Supplementary documentation

Product type	Documentation type	Documentation number
SQM5	Data sheet	N7815
ASZ	Data sheet	N7921

Warning notes



To avoid injury to persons, damage to property or the environment, the following warning notes should be observed!

Do not make any modifications to the modules!

- All activities (mounting, installation and service work, etc.) must be carried out by qualified staff
- Before performing any wiring changes in the connection area, completely isolate the burner control from the mains supply (all-polar disconnection)
- Ensure protection against electric shock hazard by providing adequate protection for the burner control's connection terminals
- Each time work has been carried out (mounting, installation, service work, etc.), check to ensure that wiring is in an orderly state
- In the event of failure, the AGA56 function modules do not have any integral/integrated/built-in safety features. Hence, depending on the application and the requirements, adequate safety measures outside the modules must be taken

Mounting notes

Ensure that the relevant national safety regulation are complied with.

Installation notes

When making the wiring, ensure that 230 V AC mains voltage is strictly separated from protective low-voltage.

Standards and certificates



Note!
Only in connection with the SQM5!



EAC Conformity mark (Eurasian Conformity mark)



ISO 9001:2015
ISO 14001:2015
OHSAS 18001:2007



China RoHS
Hazardous substances table:
<http://www.siemens.com/download?A6V10883536>

Disposal notes

The AGA56 contains electrical and electronic components and must not be disposed of together with domestic waste. Local and currently valid legislation must be observed.

Type summary (other types of modules on request)

Functions	Control inputs	Position feedback signal	Operating voltage (50...60 Hz)	Article no.	Type reference	Identification letter ¹⁾
Manual control	---	---	24...240 V AC	BPZ:AGA56.1A97	AGA56.1A97	A
Adjustment of control range Manual control	4...20 mA	---	100...120 V AC	BPZ:AGA56.41A17	AGA56.41A17	G
			220...240 V AC	BPZ:AGA56.41A27	AGA56.41A27	G
			24 V AC	BPZ:AGA56.41A87	AGA56.41A87	G
	0–2 V DC in connection with 0–135 Ω ASZs (balance relay) up to 0–1000 Ω ²⁾)	---	100...120 V AC	BPZ:AGA56.42A17	AGA56.42A17	H
			220...240 V AC	BPZ:AGA56.42A27	AGA56.42A27	H
			24 V AC	BPZ:AGA56.42A87	AGA56.42A87	H
	0...10 V DC	---	100...120 V AC	BPZ:AGA56.43A17	AGA56.43A17	K
			220...240 V AC	BPZ:AGA56.43A27	AGA56.43A27	K
			24 V AC	BPZ:AGA56.43A87	AGA56.43A87	K
Adjustment of control range Linearization of angle of rotation Readjustment of control signal Presetting of fixed position Manual control	0...20 mA 4...20 mA 0...10 V DC 0–2 V DC in connection with 0–135 Ω ASZs (balance relay) up to 0–1000 Ω ²⁾)	0...20 mA 4...20 mA 0...10 V DC	100...120 V AC	BPZ:AGA56.9A17	AGA56.9A17	Z
			220...240 V AC	BPZ:AGA56.9A27	AGA56.9A27	Z
			24 V AC	BPZ:AGA56.9A87	AGA56.9A87	Z

¹⁾ Type suffix (6th digit after the dot)

²⁾ Any intermediate range possible

Ordering

Delivery of the AGA56 and ASZ:

- | | |
|--------------------------|-------------------------------------------------------------------------------------------------------------------|
| • Integrated in the SQM5 | Part of type reference of the SQM5, via identification letter and identification number (refer to «Type summary») |
| • As an individual item | For type references of the AGA56 and ASZ, refer to <i>Type summary</i> and <i>Accessories</i> |

Accessories

Potentiometers

Each AGA56 requires **one** ASZ.

	Article no.	Type reference	Identification number *)
1000 Ω / 90° / conductive plastic	BPZ:ASZ12.803	ASZ12.803	3
1000 Ω / 135° / conductive plastic	BPZ:ASZ12.833	ASZ12.833	4
1000 Ω / 1000 Ω / 90° / conductive plastic	BPZ:ASZ22.803	ASZ22.803	7
1000 Ω / 1000 Ω / 135° / conductive plastic	BPZ:ASZ22.833	ASZ22.833	8

*) Type suffix (7th digit after the dot)

Technical data

General data	Type reference	Operating voltage	
	<ul style="list-style-type: none"> • AGA56.xA27 • AGA56.xA17 • AGA56.xA87 • AGA56.xA97 	220 V AC –15 %...240 V AC +10 % 100 V AC –15 %...120 V AC +10 % 24 V AC –15 % / +10 % 24 V AC –5 %...240 V AC +10 %	
	Frequency	50...60 Hz ±6 %	
	Degree of protection	IP 54 to IEC 529, when mounted in the SQM5	
	Safety class	to IEC 730-1, when mounted in the SQM5	
	<ul style="list-style-type: none"> • AGA56.xA17, AGA56.xA27 • AGA56.xA87 	I III	
	Input resistance		
	<ul style="list-style-type: none"> • Current input • Voltage input 	≤ 300 Ω ≥ 100 kΩ	
	Power consumption	2.8 VA (without actuator)	
	Vibrations	30 m/s ² (3 g) to IEC 68-2-6	
	Vibration range	2...100 Hz	
	Perm. input line lengths	≤ 100 m	
	Temperature drift of output signals	≤ 2.5 % referred to entire ambient temperature range	
	Weight	approx. 330 g	
	Perm. loading on outputs		
	<ul style="list-style-type: none"> • Current output • (Current) total load • Voltage output • Total load 	short-circuit-proof to IEC 381 max. 600 Ω ≥ 1.5 kΩ all simultaneously to IEC 381	
	DC current signals	to IEC 381 T1	
	DC voltage signals	to IEC 381 T2	
	For assignment of connection terminals and further specification of the inputs and outputs, refer to «Assignment of terminals / Legend»		
	Environmental conditions	Storage	DIN EN 60 721-3-1
		Climatic conditions	class 1K3
		Mechanical conditions	class 1M2
		Temperature range	-20...+60 °C
Humidity		< 95 % r.F.	
Transport		DIN EN 60 721-3-2	
Climatic conditions		class 2K2	
Mechanical conditions		class 2M2	
Temperature range		-30...+60 °C	
Humidity		< 95 % r.h., Climate F to DIN 40 040	
Operation		DIN EN 60 721-3-3	
Climatic conditions		class 3K5	
Mechanical conditions		class 3M2	
Temperature range		-20...+60 °C	
Humidity		of SQM5 with AGA56 build in < 95 % r.h., Climate F to DIN 40 040	



Warning!
Condensation, formation of ice and ingress of water are not permitted!
Failure to observe this poses a risk of damaging the safety functions and a risk of electric shock.

Function

The following functions are provided:

- Manual control
- Adjustment of the control range
- Linearization of the angle of rotation
- Readjustment of the control signal
- Presetting the fixed position

(For availability, refer to «Type summary / Functions»)

Manual control

After switching the “MAN/AUTO” switch from “AUTO” (automatic operation) to “MAN” (manual operation), the SQM5 can be opened or closed using the “▲/0/▼” switch.

Adjustment of the control range

Using the two ASZs “MIN” and “MAX”, the positioning range of the SQM5 can be limited to between 0° and 90° or 135°.

Adjusting the limitations

- Set switch «S1» to «MIN»
- Set “MIN” ASZ to a position between 0° and 67.5° or 101°
- Set switch «S1» to «MAX»
- Set “MAX” ASZ to a position between the previously set “MIN” angle and 90° or 135°
- **The «MAX» angle value must be greater than the «MIN» angle value!**
- Set switch «S1» to «OPE». In operation, switch «S1» must be in position «OPE»

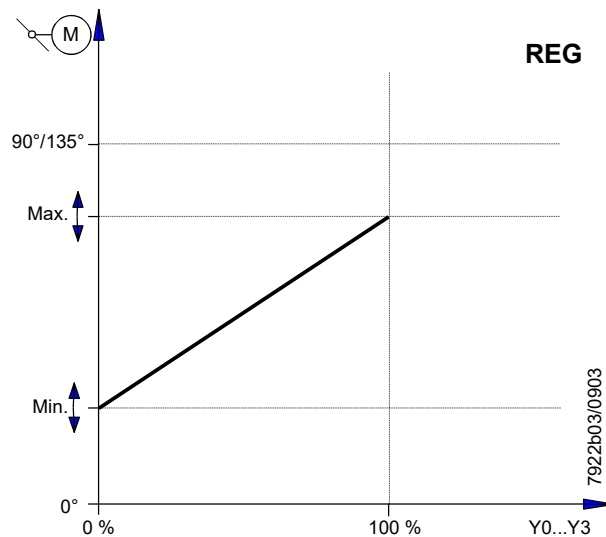

Readjustment of the control signal

The control signal can be readjusted using the external «ZF» signal (4...20 mA).

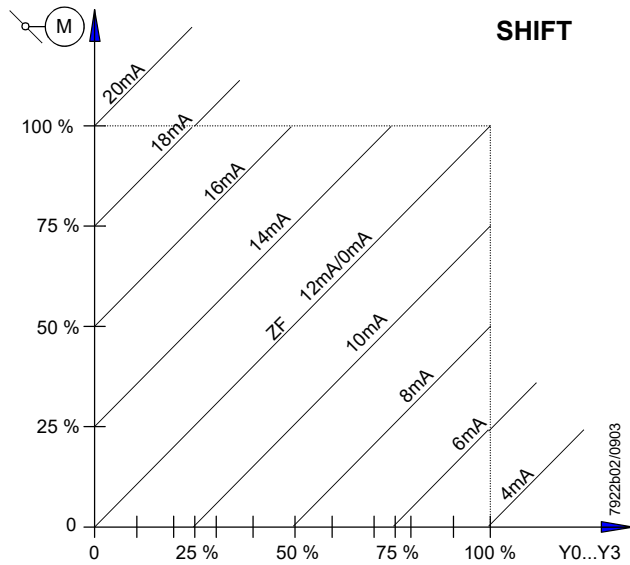

- Legend
- M Air damper actuator
 - REG Adjustment of the control range
 - SHIFT Readjustment of the control signal
 - Y0...Y3 Control inputs
 - ZF External signal for SHIFT

For specification, refer to «Assignment of terminals»

Linearization of the angle of rotation

By setting jumper "J1" to position "1", the proportional behavior of the SQM5 (curve ②) can be matched to the control (curve ①). In the case of small signals, linearization of the angle of rotation produces over proportionally small angular changes and, in the case of greater signal, over proportionally large angular changes. Used in connection with non-linear regulating units, such as air dampers.

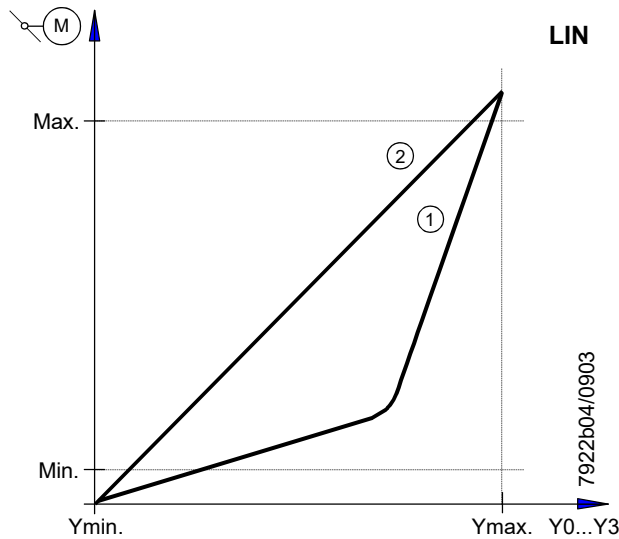

Function (cont'd)

Presetting the fixed position

The rotation angle position of the SQM5 can be preset using the ASZ "POS". This position is approached independent of control signals when operating voltage is present at the input of «POS» (Terminal «P»). Position «POS» can be adjusted within the entire range of angular rotation.

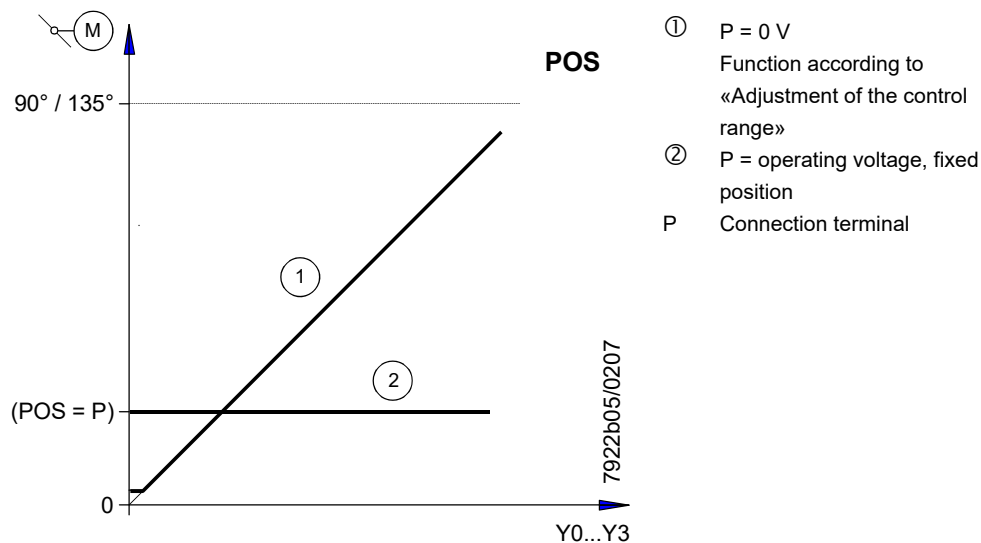

Basic circuit diagram

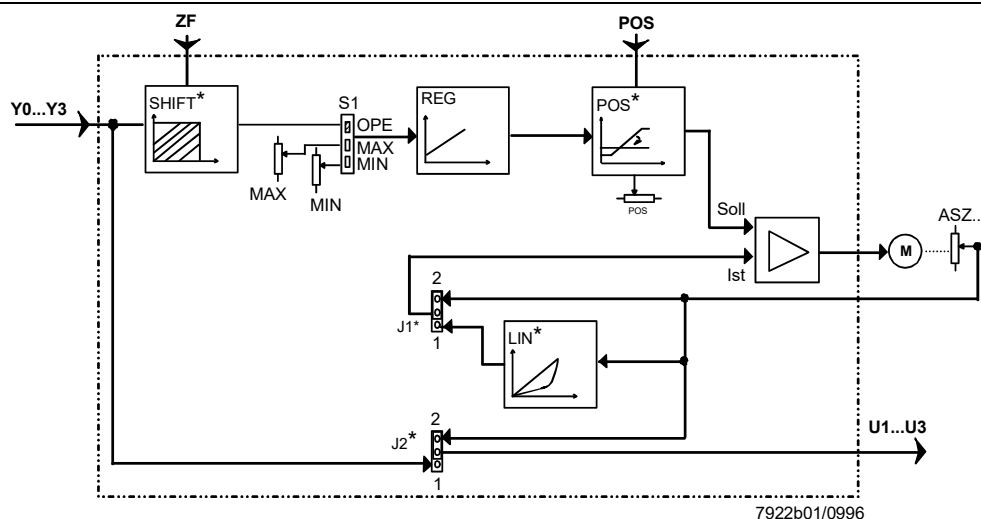

* Only contained in the AGA56.9!

Legend

ASZ	Potentiometer	POS	Preset fixed position
Ist	Actual value	REG	Adjustment of the control range
J1	Shorting plug	S1	Switch
J2	Shorting plug	SHIFT	Readjustment of the control signal
L	Live conductor	Soll	Setpoint
LIN	Linearization of angle of rotation	U1...U3	Control outputs
M	Air damper actuator	Y0...Y3	Control inputs
OPE	Operating position	ZF	External signal for SHIFT

Assignment of terminals

	Safety extra low-voltage terminals	Operating voltage terminals	
AGA56.9			Screw terminals for single-wire cables up to 2.5 mm ² (AWG12)
AGA56.41			Terminals to RAST5 standard, also suited for use with quick connectors to DIN 46 244-A 6.3-0.8
AGA56.42			Terminals to RAST5 standard, also suited for use with quick connectors to DIN 46 244-A 6.3-0.8
AGA56.43			Terminals to RAST5 standard, also suited for use with quick connectors to DIN 46 244-A 6.3-0.8

Legend		
A	Signal for opening the SQM5 → Limited by end switch in the SQM5	
L	Live conductor	
L1, LR	Enabling control	
M	Ground	
N	Neutral conductor	
P	Positioning signal	
U, U4	Constant 2 V DC supply voltage for an external ASZ 135–1,000 Ω – for example, in connection with a balance relay system	
U1	Control output 0...10 V DC	
U2	Control output 0...20 mA	
U3	Control output 4...20 mA	
Yo	0–2 V DC control input from an external ASZ 135–1,000 Ω – for example, in connection with a balance relay system	
Y1	Control input 0...10 V DC	
Y2	Control input 0...20 mA	
Y3	Control input 4...20 mA	
Y+	Control input +pole	

Y-	Control input -pole
Y	AGA56.42: same as Yo AGA56.43: same as Y1
Z, 13	Signals for closing the SQM5, the CLOSED position is limited by the end switch in the SQM5, 2 parallel inputs for... - the signal from the burner control AND - the feedback of the internal control signal "ZL" of the AGA56 (bridge ZL → 13) <u>Use:</u> Air damper does not close when burner is «OFF», that is, when «Ignition position» corresponds to the «CLOSED» position. Ends of output cables no. 3 and no. 13 must be stripped
ZF	Control input 4...20 mA for readjustment of the control signal
ZL	Signal for closing the SQM5 → Limited by auxiliary switch in the SQM5 <u>Example:</u> ignition load

Following applies to 24 V AC versions:

Go = N = M

G = L

Signals and power supply with **operating voltage**
A, L, Z, ZL, 13, L1, P, LR



The following signals must not be present at the same time:

- L1, LR with A, Z, ZL or 13
- A with Z, ZL or 13

- Manual control

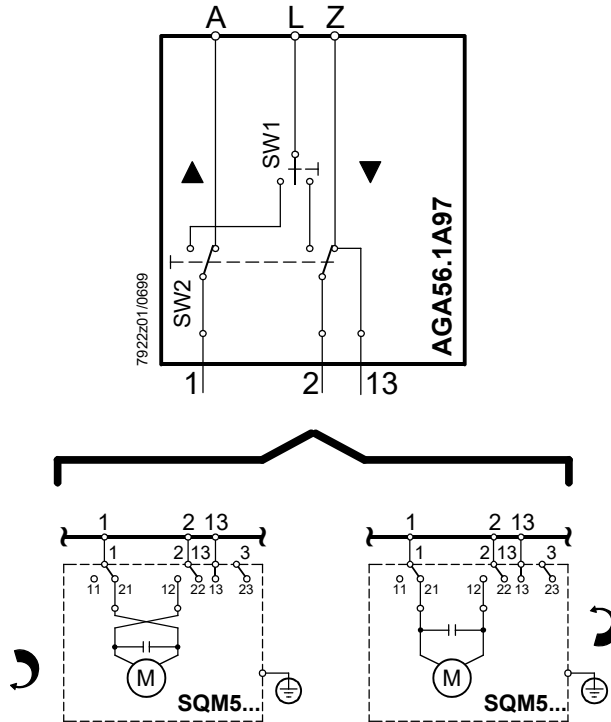

- Manual control
- Adjustment of the control range

...A87 : AC 24 V / 50...60 Hz
 ...A27 : AC 220...240 V / 50...60 Hz
 ...A17 : AC 100...120 V / 50...60 Hz

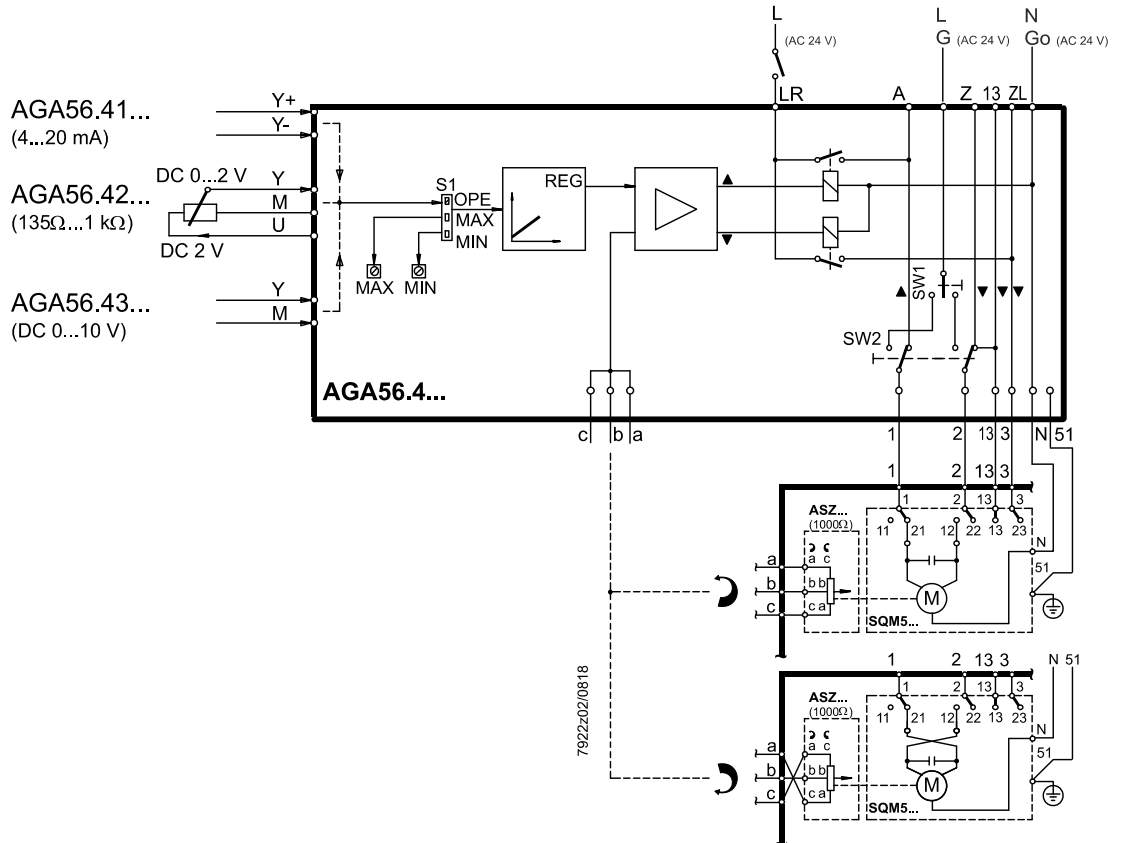

Internal diagrams and connection diagrams (cont'd)

AGA56.9

- Manual control
- Adjustment of the control range «REG»
- Readjustment of the control signal «SHIFT»
- Linearization of the angle of rotation «LIN»
- Presetting the fixed position «POS»

...A87 : AC 24 V / 50...60 Hz
 ...A27 : AC 220...240 V / 50...60 Hz
 ...A17 : AC 100...120 V / 50...60 Hz

