

Data Sheet

# Pressure switch Type **RT**

For industrial and marine applications



RT pressure switches incorporate a pressure controlled, single-pole change over switch where the contact position depends on the pressure in the connection port and the set value.

The RT series consists of pressure switches, differential pressure switches and pressure switches for neutral zone regulation, all for general use within the industrial and marine segments. The series also covers safety pressure switches dedicated for steam boiler plants.

For installations in which operation is particularly critical from safety and economic points of view, the use of fail-safe pressure switches is recommended.

The use of gold-plated contacts is also recommended in such installations, provided operation involves only a few switching cycles or signal currents and voltages.

**Features:**

- Simple design
- High accuracy
- High repeatability
- Long operation life time
- Available with all major marine approvals
- Safety Integrity Level: SIL 2 according to IEC 61508

**Portfolio overview**

**Overview / Survey**

Figure 1: Overview / Survey

0	5	10	15	20	25	30[bar]	Range p <sub>e</sub> [bar]	Type
[Grid]							-1 - 0	RT 121
[Grid]							0 - 0.3	RT 113
[Grid]							0.1 - 1.1	RT 112
[Grid]							0.2 - 3	RT 110
[Grid]							-0.8 - 5	RT 1 / RT 1A
[Grid]							0.2 - 6	RT 200
[Grid]							1 - 10	RT 116
[Grid]							4 - 17	RT 5 / RT 5A
[Grid]							10 - 30	RT 117
[Grid]							0.1 - 1.1	RT 112
[Grid]							0 - 2.5	RT 33B / RT 35W
[Grid]							1 - 10	RT 30AW / RT 30AB / RT 30AS
[Grid]							2 - 10	RT 31W / RT 31B / RT 31S
[Grid]							5 - 25	RT 19W / RT 19B / RT 19S
[Grid]							5 - 25	RT 32W / RT 32B
[Grid]							-0.8 - 5	RT 1 AL
[Grid]							0.2 - 3	RT 110L
[Grid]							0.2 - 6	RT 200L
[Grid]							4 - 17	RT 5AL
[Grid]							10 - 30	RT 117L
[Grid]							-1 - 6	RT 266AL
[Grid]							-1 - 6	RT 263AL
[Grid]							-1 - 9	RT 262AL / RT 262A
[Grid]							-1 - 18	RT 260AL / RT 260A
[Grid]							-1 - 36	RT 260A
[Grid]							-1 - 36	RT 265A

- A** Standard pressure switches
- B** Pressure switches for steam plant approved by TÜV
- C** Pressure switches with adjustable neutral zone
- D** Differential pressure switches

Table 1: Examples of RT types

RT 113	RT 116	RT 262 A
For manual setting; cover with windows	For tamper proof; cap and blank cover	Differential pressure switch

**Function**

**RT 19, RT 30 and pressure switches with max. reset**

When the pressure exceeds the set range value, contacts 1-4 make and contact 1-2 brake. The contacts changeover to their initial position when the pressure falls to the range value minus the differential (see [Figure 3: Contact function, setting for rising pressure.](#)).

Figure 2: Contact function, setting for rising pressure.

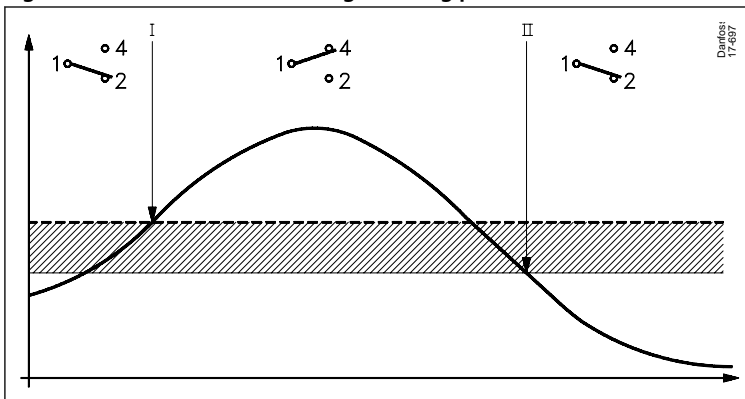

---	Scale setting
	Mechanical differential

Contact function:

- I. Alarm for rising pressure given at the set range value.
- II. Alarm for falling pressure given at the set range value minus the differential.

Units with max. reset can only be reset at a pressure corresponding to the set range value minus the differential, or a lower pressure.

**All other RT pressure switches**

When the pressure falls to the set range value, contacts 1-2 make and contacts 1-4 brake. The contacts changeover to their original position when the pressure again rises to the set range value plus the differential (see [Figure 3](#)).

Figure 3: Contact function, setting for falling pressure.

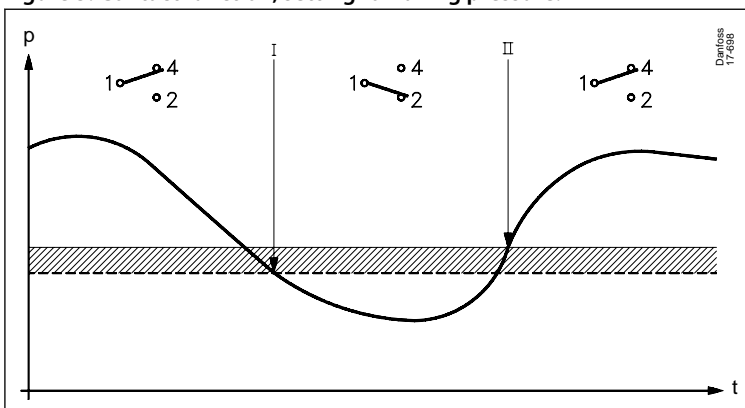

---	Scale setting
	Mechanical differential

Contact function:

- I. Alarm for falling pressure given at the set range value.
- II. Alarm for rising pressure given at the set range value plus the differential.

Units with min. reset can only be reset at a pressure corresponding to the set range value plus the differential.

**Example 1:**

An extra cooling water pump must start if the cooling water pressure falls below 6 bar, and must stop when the pressure exceeds 7 bar.

Choose an RT 116 with a range of 1 – 10 bar and an adjustable differential of 0.2 – 1.3 bar.

The start pressure of 6 bar must be set on the range scale. The differential must be set as the difference between the stop pressure (7 bar) and the start pressure (6 bar) = 1 bar. According to [Figure 25](#), the differential setting disc must be set on 8.

**Example 2:**

The burner on a steam boiler must cut out when the pressure exceeds 17 bar. Automatic restart must not occur.

Choose an RT 19B with external reset. If extra safety is demanded, an RT 19S with internal max. reset can be used.

The range is 5 – 25 bar and the differential is fixed at approx. 1 bar. The range scale must be set at 17 bar. After cut-out of the burner, manual reset is possible only when the pressure had fallen to the setting of 17 bar minus the differential: in this case, 16 bar and below.

**Example 3:**

The min. permissible lubricating oil pressure for a gear is 3 bar. Reset must not be possible until the reason for oil pressure failure has been investigated. Choose an RT 200 with min. reset.

The range value must be set while reading the range scale. Manual reset is possible only when the pressure has reached 3.2 bar (the differential is fixed at 0.2 bar or higher).

**Functional description of RT units with fail-safe design**

**Fail-safe function for falling pressure**

Figure 4: Cross-section of RT 32W

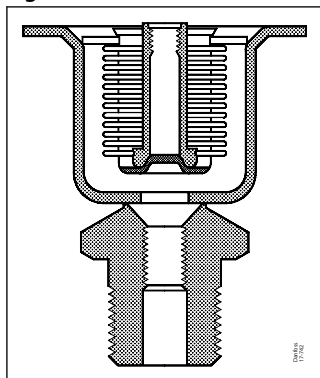
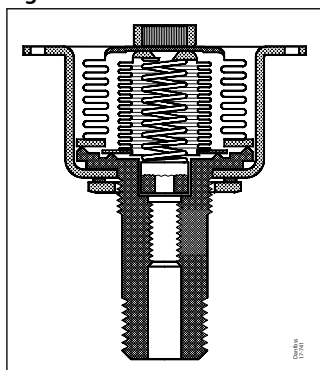

Figure 4 shows a cross-section of a bellows element for the RT 32W with fail-safe function for falling pressure. On rising pressure the contact arm is actuated to break the connection between terminals 1 and 2.

On falling pressure the contact arm is actuated to break the connection between terminals 1 and 4. If a defect occurs in the bellows the setting spring actuates the contact arm to break the connection between terminals 1 and 4, as in the case of falling pressure. This will occur irrespective of the pressure on the bellows.

**Fail-safe function for rising pressure**

Figure 5: Cross-section of RT 30W



## Pressure switch, Type RT

**Figure 5** shows a cross-section through a bellows element for the RT 30W with fail-safe for rising pressure. On rising pressure the contact arm is actuated to break the connection between terminals 1 and 2.

If a defect occurs in the inner bellows the pressure is led to the outer bellows. The outer bellows has an area three times as large as the inner bellows. The connection between terminals 1 and 2 becomes broken.

If a defect occurs in the outer bellows, there will be atmospheric pressure in the gap between the two bellows. This actuates the contact system to break the connection between terminals 1 and 2. The important factor with the double bellows design is the vacuum between the two bellows, and that in case of bellows break, no media will leak into the environment.

### **Pressure switches for liquid level control RT 113**

The RT 113 pressure switch can be used to control the liquid level in open tanks. **Figure 6** shows in principle, four different types of installation.

#### **1. With air bell** (see [Spare parts and accessories](#))

For control purpose, the air bell should be installed 20 – 40 mm below the lowest liquid level. In addition, the tube between the RT 113 and the air bell must be absolutely airtight. If only an indication is required, the bell can be placed 100 mm below the max. level. The RT 113 must be set at 0 cm wg and the differential disc on 1.

#### **2. Connection to the side of the tank with the RT 113 above the liquid level**

The horizontal tube A must have a certain length in relation to the vertical tube B in order to ensure reliable control. The length of A can be found from **Figure 7**, using B and the range setting pressure C.

#### **3. Connection to the side of the tank with the RT 113 below the liquid level**

Where possible, this form of connection should be used. If an air-absorbing liquid like oil is involved, it is preferable to 1 and 2. The resulting range setting is the distance from the liquid surface to the centre of the diaphragm housing.

#### **4. Connection in the tank with the RT 113 above the liquid level**

This method is for use with air-absorbing liquids where connection type 3 is not possible. The shortest horizontal tube length is determined as described in 2. A shut-off valve is installed between the oil tank and water reservoir shown so that impurities can be drained from the water reservoir through a bottom drain plug. Fresh water can then be poured into the reservoir through a filling connector in its top.

**Figure 6: Four variants of installation**

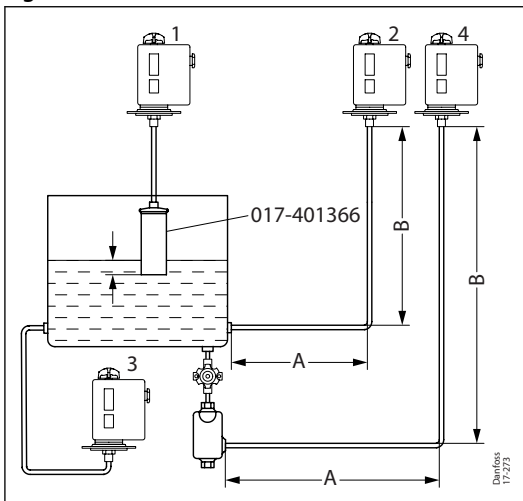

**Figure 7: Chart for length of A**

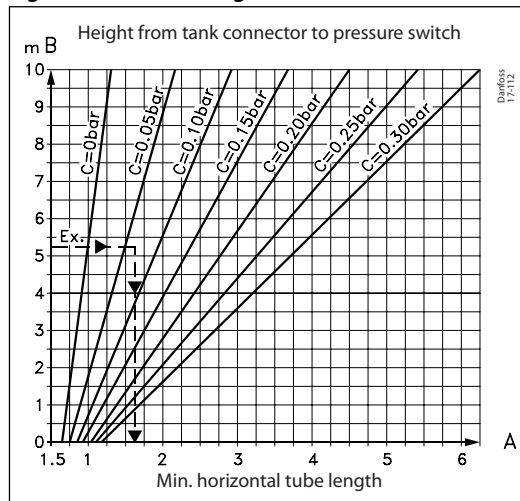

### **Units with changeover switch (SPDT)**

If the differential pressure falls below the set value, contacts 1-2 make and contacts 1-4 break. Contacts 1-2 break again and contacts 1-4 make when the differential pressure has risen to the set range value plus the fixed contact differential.

Figure 8: Contact function, setting of falling differential pressure

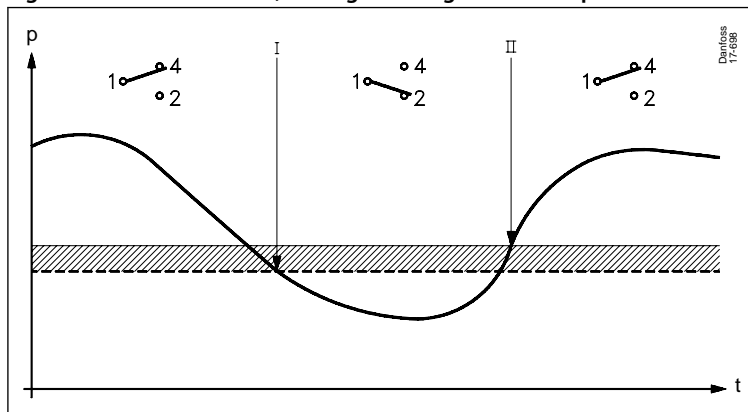

---	Scale setting
	Mechanical differential

Contact function:

- I. Contacts make when differential pressure falls below the range scale setting.
- II. Contacts make when pressure rises above the range scale setting plus the fixed mechanical differential.

### Units with adjustable neutral zone (SPDTNP)

If the differential pressure rises above the set value plus the differential, contacts 1-4 make. If the pressure falls by the amount of the differential (which is fixed in this unit), contacts 1-4 break. If the pressure falls to the neutral zone minus the differential, contacts 1-2 make. When the differential pressure rises again by an amount corresponding to the differential, contacts 1-2 break again.

The contact function can be summed up as follows:

- I. Setting disc set for falling differential pressure.
- II. Neutral zone disc set for rising differential pressure.

Figure 9: Contact function, setting of neutral zone

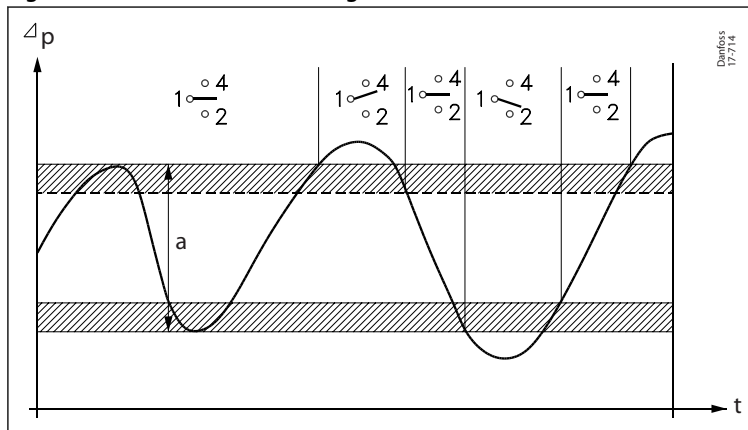

---	Range setting inlet pressure
	Mechanical differential
	Differential (mechanical differential) corresponds to the least neutral zone setting.
<b>a</b>	The neutral zone and inlet differential pressure may vary within this interval without resulting in a make function 1-2 or 1-4.

#### Example 1:

When the differential pressure exceeds 1.3 bar, a filter needs cleaning. The static pressure over the filter is 10 bar.

According to the ordering table on page 4, the choice is an RT 260A (the RT 262A has a max. operating pressure on the low pressure side (LP) of 9 bar and is therefore not suitable for this application).

Setting: Since a signal is required for rising differential pressure, the setting becomes 1.3 - 0.3 bar = 1.0 bar.

#### Example 2:

The speed of a circulation pump must be controlled to give a constant differential pressure of 10 m wg in a heating plant. The static plant pressure is 4 bar. The choice is an RT 262AL.

The differential disc (5), see [Figure 17](#), must be set at 1 bar (10 m wg) minus the fixed differential of 0.1 bar, i.e. 0.9 bar. The neutral zone disc is factory-set (marked in red).

**Application**

RT-L pressure switches are fitted with a switch with an adjustable neutral zone. This enables the units to be used for floating control. The terminology involved is explained below.

Figure 10: Application

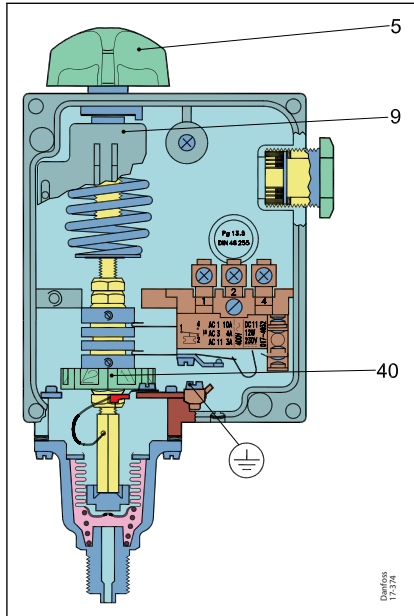

5	Setting knob
9	Range scale
40	Neutral zone disc

**Floating control**

A form of discontinuous control where the correcting element (e.g. valve, damper, or similar) moves towards one extreme position at a rate independent of the magnitude of the error when the error exceeds a definite positive value, and towards the opposite extreme position when the error exceeds a definite negative value.

**Hunting**

Periodic variations of the controlled variable from the fixed reference.

**Neutral zone**

The interval in the controlled variable in which the correcting element does not respond, see Figure 15.

The contact system in neutral zone units cannot be exchanged, as the contact system adjustment is adjusted to the other parts of the unit.

**Setting of neutral zone**

The range is set using the setting knob (5), see Figure 10, while reading the range scale (9). The pressure set is the break pressure for contacts 1-4, see Figure 15.

The required neutral zone can be found in the diagram for the unit concerned. The position at which the neutral zone disc (40) must be set can be read from the lower scale in the diagram. The function can be seen in Figure 15.

Table 2: Neutral zone setting

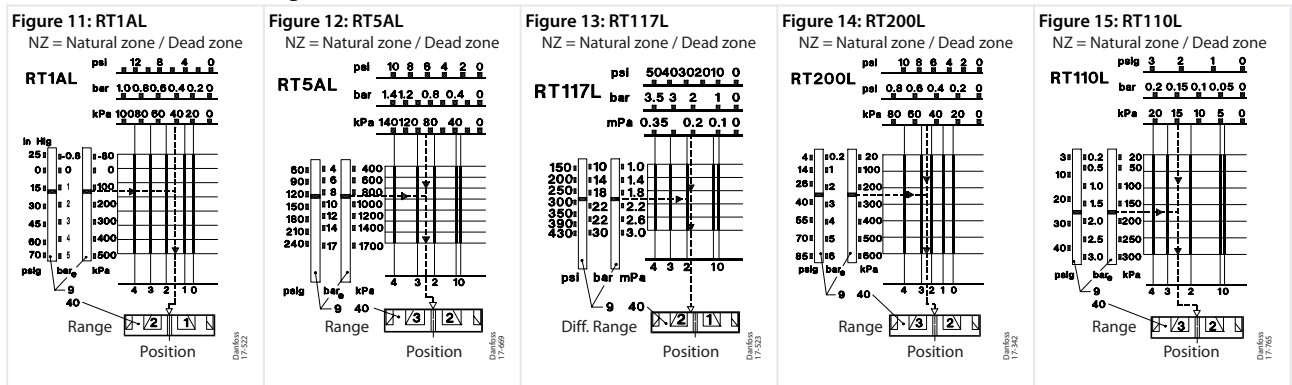

**Example:**

Together with a VLT® static frequency converter, RT 200L neutral zone pressure switches can be used for the infinite control of a pump in, for example, a pressure boosting plant. In this case, the pump must be up and downregulated at 32 m and 25 m wg. The RT 200L must be set using the setting knob (5), see Figure 10, at 3.5 bar (35 m wg) minus the fixed differential of 0.2 bar.

The range setting is  $3.5 - 0.2 = 3.3$  bar.

## Pressure switch, Type RT

The neutral zone,  $35 - 32 = 3$  m wg, corresponding to 0.3 bar, must be set on the neutral zone disc (40), see [Figure 10](#). According to the diagram, see [Figure 14](#), the disc setting is 1 or just over. A more accurate setting can be obtained by using the test setup shown in [Figure 16](#).

**Figure 16: Test setup for setting the pressure switch**

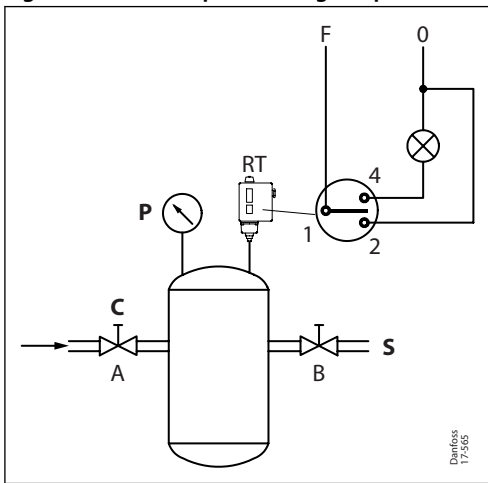

P	Pressure gauge
C	Compressed air
S	Signal lamp for falling and rising pressure

### **Control and monitoring of pressure differentials**

A differential pressure switch is a pressure controlled switch that cuts in and cuts out the current dependent on the pressure differential between the counteracting bellows elements and the set scale value. This unit is also available with an adjustable neutral zone (like the RT-L which is described on [Setting of neutral zone](#)).

### **Setting**

The setting disc (5) becomes accessible when the front cover is removed. The differential pressure is set by turning the disc with a screwdriver while reading the scale (9).

For differential pressure switches with a changeover contact system, the contact differential is given as the differential pressure switches have a fixed differential. In units with an adjustable neutral zone, the neutral zone disc must also be set. See [Table 3: Neutral zone setting](#).



Pressure switch, Type RT

Figure 17: Differential pressure switch

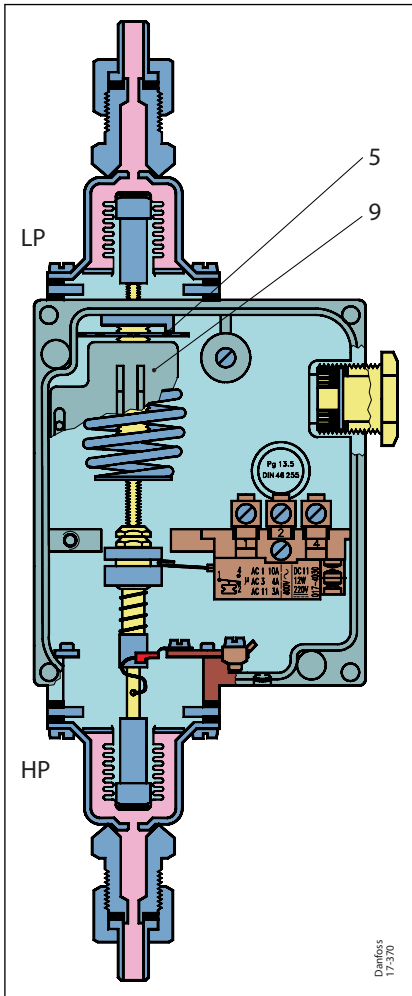

LP	Low pressure
HP	High pressure
5	Setting disc
9	Range scale

**NOTE:**

When installing, the low pressure connection (LP) must always be upwards.

Table 3: Neutral zone setting

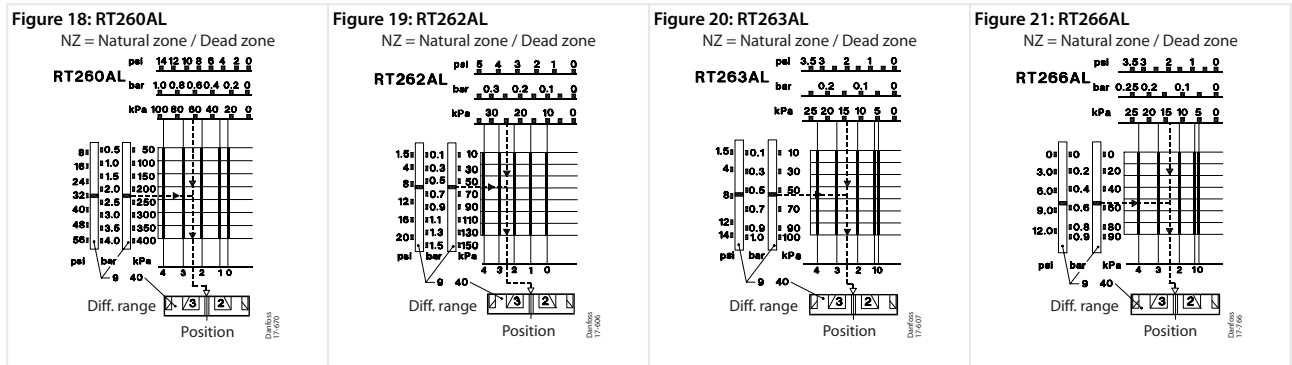

**Product specification**

**Technical data**

**Table 4: Technical data**

Designation	RT pressure switches
Ambient temperature	In general -50 – 70 °C Diaphragm version -10 – 70 °C TÜV approved -40 – 70 °C
Media temperature	In general -50 – 100 °C Diaphragm version -10 – 90 °C TÜV appr. -40 – 150 °C
Contact system	Single-pole changeover switch (SPDT), see <a href="#">Figure 22</a>
Contact load	<i>Alternating current:</i> AC-1: 10A, 400 V AC-3: 4A <sup>(1)</sup> , 400 V AC-15: 3A <sup>(1)</sup> , 400 V
Contact material: AgCdO	<i>Direct current:</i> DC-13: 12 W, 220 V (see <a href="#">Figure 23</a> )
Special contact system	See <a href="#">Spare parts and accessories</a>
Cable entry	2 PG 13.5 for 6 – 14 mm diameter cables
Solid / stranded	0.2 – 2.5 mm <sup>2</sup>
Flexible, without ferrules	0.2 – 2.5 mm <sup>2</sup>
Flexible, with ferrules	0.2 – 1.5 mm <sup>2</sup>
Tightening torque	max. 1.5 Nm
Enclosure	IP66 acc. to IEC 529 and EN 60529. Units supplied with external reset. IP54. The thermostat housing is made of bakelite acc. to DIN 53470 Cover is made of polyamide.

<sup>(1)</sup> According to EN12953-9 and EN12952-11 standards the contact load must not be higher than AC-3: 2A, 400 V and AC-15: 1A, 400 V.

**Figure 22: Contact system**

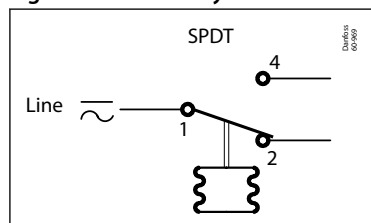

**Figure 23: Direct current**

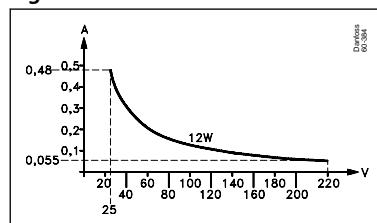

**Materials in contact with the medium**

**Table 5: Materials in contact with the medium**

Material	Part	W.no.	DIN	RT 1	RT 1A	RT 5	RT 5A	RT 110	RT 112	RT 113	RT 116	RT 117	RT 121	RT 200 / RT 200L	RT 260A	RT 260A / 262A / RT 262AL	RT 260AL	RT 265A	RT 263AL RT 266AL
Stainless steel 18/8	Bellows	1.4306	17440	x	x	x	x	x	x		x	x	x	x	x	x	x	x	x
Stainless steel 17/7	Spring	1.4568	17224	x						x		x	x	x					
Brass	Housing	2.0402	17660			x		x	x		x	x	x	x					
Brass	Bellows ring	2.0321	17660			x		x	x		x	x	x	x					
Free-cutting steel	Flare connection	1.0718	1651	x															
Deep-drawn steel (nick.plated surface)	Housing	1.0338	1623	x	x		x								x	x	x	x	x

## Pressure switch, Type RT

Material	Part	W .no.	DIN	RT 1	RT 1A	RT 5	RT 5A	RT 110	RT 112	RT 113	RT 116	RT 117	RT 121	RT 200 / RT 200L	RT 260A	RT 260A / 262A / RT 262AL	RT 260AL	RT 265A	RT 263AL RT 266AL
Non-alli. carbon steel C 20	Weld connect. for connection	1.0402	1652		x		x								x	x	x	x	x
Aluminium	Gasket	3.0255	1712		x		x			x					x	x	x	x	x
NBR rubber	Diaphragm									x									
Deep-drawn steel (surface DIN 50961 weld connection Fe/Zn 5C)	Diaphragm housing with welded connector	1.0338	1623							x									
Spring thread	Spring	1.1250	17223		x														

**Table 6: Materials in contact with the medium, PED approved switches**

Material	Part	W .no.	DIN	RT 19W / RT 19B / RT 19S	RT 30AW / RT 30AB / RT 30AS	RT 31W / RT 31B / RT 31S	RT 32WB	RT 33B / RT 35W	RT 112 W
Stainless steel 18/8	Bellows	1.4301	17440	x	x	x	x	x	x
Stainless steel 17/7	Orifice	1.4305	17440	x	x				
Steel C 15	Connector	1.0401	1652	x	x				
Deep-drawn steel + Ni	Bellows ring	1.0338	1623	x	x	x	x	x	x
Stainless steel 17/7	Bellows spring	1.4568	17224		x			x	
Stainless steel	Ring	1.4305	17440		x				
Deep-drawn steel + Ni	Housing	1.0338	1623	x	x	x	x	x	x
Stainless steel	Bellows connect.	1.4305	17440			x			
Stainless, weldable freecutting steel	Connector	1.4301	17440			x	x	x	x
Deep-drawn steel + Sn	Spring guide	1.0338	1623					x	
Brass	Housing	2.0402	17660						
Brass	Bellows ring	2.0321	17660						

## Installation

RT units have two mounting holes which become accessible when the front cover is removed. Units fitted with switch 017-018166<sup>(1)</sup> must be installed with the setting knob upwards. When installing differential pressure switches, the low pressure side (marked LP) must be installed upwards.

The other pressure switches in the RT series can be installed in any position, expect that on plant subjected to severe vibrations it is advantageous to have the screwed cable entry downwards.

**Figure 24: Positioning of unit**

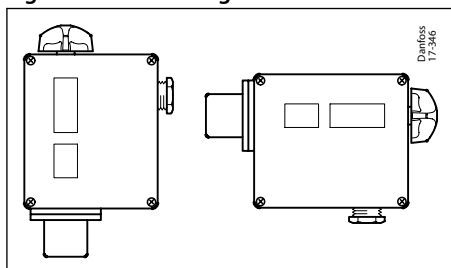

### Pressure connection

When fitting or removing pressure lines, the spanner flats on the pressure connection should be used to apply counter-torque.

<sup>1</sup> Contact system with snap-action contact. See [Spare parts and accessories](#).

## Pressure switch, Type RT

### Steam plant

To protect the pressure element against temperature in excess to the maximum temperature of the medium 150 °C (RT 113 90 °C), the insertion of water-filled loop is recommended.

### Water systems

Water in the pressure element is not harmful, but if frost is likely to occur a water-filled pressure element may burst. To prevent this happening, the pressure control can be allowed to operate on an air cushion.

### Media resistance

Refer **Materials in contact with the medium**. If seawater is involved, diaphragm pressure switches types KPS 43, KPS 45 and KPS 47 are recommended.

### Pulsations

The pressure switch must be connected in such a way that the pressure element is affected by pulsations as little as possible. A damping coil can be inserted (see **Spare parts and accessories**). With strongly pulsating media, diaphragm pressure switches types KPS 43, KPS 45 and KPS 47 can be advantageous.

### Setting

The range is set by using the setting knob (5) while at the same time reading the scale (9). Tools must be used to set pressure switches fitted with a seal cap.

Figure 25: Setting

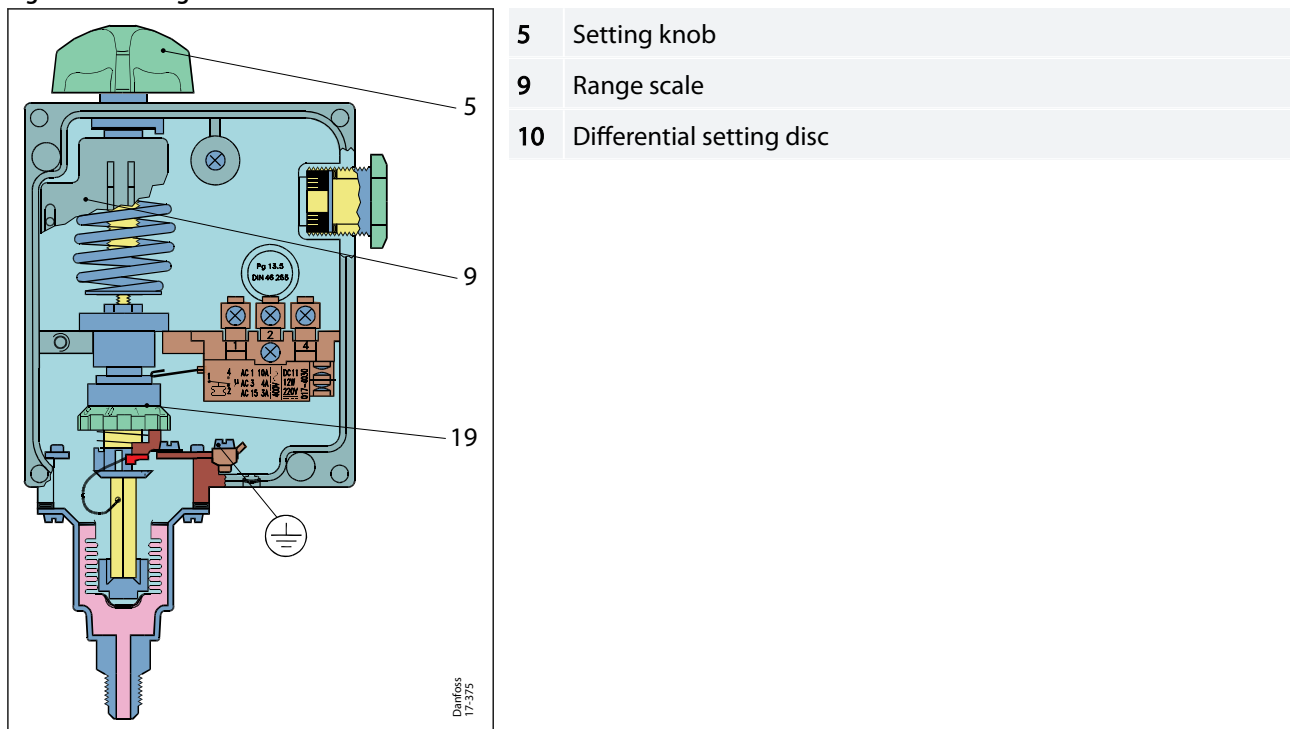

In units having a fixed differential, the difference between cut-in and cut-out pressures is of course determined. On units having an adjustable differential the front cover must be removed. The differential disc (19) must be set in accordance with the diaphragm.

### Selection of differential

To ensure that the plant functions properly, a suitable differential pressure is necessary. Too small a differential will give rise to short running periods with a risk of hunting. Too high a differential will result in large pressure oscillations.

Differential scale values are guiding.

## Pressure switch, Type RT

Figure 26: Obtainable differential disc scale

	1	2	3	4	5	6	7	8	9	10		
RT 1 RT 1A	0.5	0.7	0.9	1.1	1.3	1.5	1.7	1.9	2.1	2.3	2.4	bar
RT 1A (017-500766)	1.3	1.5	1.7	1.9	2.1	2.3	2.4					bar
RT 5 RT 5A	1.2	1.6	2.0	2.4	2.8	3.2	3.6	4.0				bar
RT 31W (017-5267)	0.3	0.4	0.5	0.6	0.7	0.8	0.9	1.0				bar
RT 32W (017-5247)	0.8	1.2	1.6	2.0	2.4	2.8	3.0					bar
RT 110	0.08	0.11	0.14	0.17	0.20	0.23	0.25					bar
RT 112	0.07	0.085	0.10	0.115	0.13	0.145	0.16					bar
RT 113	0.01	0.02	0.03	0.04	0.05							bar
RT 116	0.3	0.5	0.7	0.9	1.1	1.3						bar
RT 121	0.09	0.15	0.2	0.25	0.3	0.35	0.4					bar
RT 200	0.25	0.4	0.6	0.8	1.0	1.2						bar
RT 117	1.0	1.3	1.5	2.0	2.5	3.5	4.0					bar

Min. 1 2 3 4 5 6 7 8 9 10 Max. 10  
Danfoss 17-502

## Dimensions and weights

Table 7: Dimensions [mm] and weights [kg]

		<p><b>RT 5, RT 110, RT 112, RT 116, RT 117, RT 200</b></p> <p>Special version with tamper proof cap and blank cover</p>	
<p><b>RT 13</b></p>	<p><b>RT 5, RT 110, RT 112, RT 116, RT 117 / RT 117L, RT 121, RT 200 / RT 200L</b></p>		<p><b>RT 5</b></p>
<p><b>RT 1A / RT 1AL</b></p>	<p><b>RT 260A / RT 260AL</b></p>	<p><b>RT 262A / RT 262A / RT 263AL</b></p>	<p><b>RT 5</b></p>
			<p><b>RT 5A / RT 5AL</b></p>

Pressure switch, Type RT

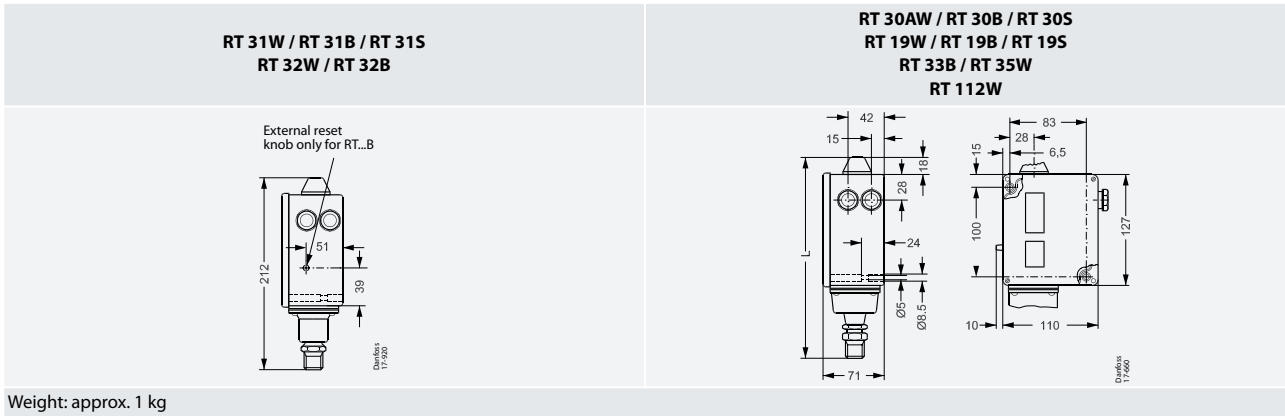

**Table 8: Overall length**

RT types	Length
RT 30AW / RT 30B / RT 30S	L = 225
RT 19W / RT 19B / RT 19S	L = 228
RT 33B / RT 35W	L = 221
RT 112W	L = 210
RT 31W / RT 31B / RT 31S	L = 212
RT 32W / RT 32B	L = 212

## Ordering

When ordering, please state type and code number.

The type designation for the letters below means:

<b>A</b>	Unit suitable for ammonia
<b>L</b>	Unit with neutral zone

## Pressure switches

Table 9: Pressure switches

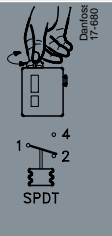
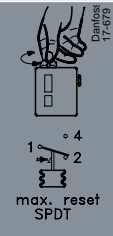
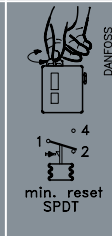
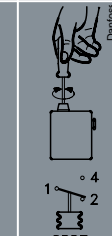
Regulation range [bar]	Adjustable/ fixed mechanical differential [bar]	Max. working pressure PS [bar]	Max. test pressure Pe [bar]	Pressure connection ISO 228/1	Code no.				Type
					 Danfoss 17-680 SPDT	 Danfoss 17-679 max. reset SPDT	 DANFOSS AT7-676,12 min. reset SPDT	 Danfoss 17-677 SPDT	
-1 – 0	0.09 – 0.4	7	8	G 3/8 A	<b>017-521566</b> <sup>(1)</sup>	–	–	–	RT 121
0 – 0.3	0.01 – 0.05	0.4	0.5	G 3/8 A	<b>017-519666</b> <sup>(1)</sup>	–	–	–	RT 113
0.1 – 1.1	0.07 – 0.16	7	8	G 3/8 A	<b>017-519166</b> <sup>(1)</sup>	–	–	017-519366	RT 112
0.1 – 1.1	0.07	7	8	G 3/8 A	–	017-519266	–	–	RT 112
0.2 – 3	0.08 – 0.25	7	8	G 3/8 A	<b>017-529166</b> <sup>(1)</sup>	–	–	017-529266	RT 110
0.2 – 3	0.08	7	8	G 3/8 A	–	–	017-511066	–	RT 110
-0.8 – 5	0.5 – 1.6	22	25	7/16-20 UNF	<b>017-524566</b> <sup>(1)</sup>	–	–	–	RT 1
-0.8 – 5	0.5	22	25	7/16-20 UNF	–	–	017-524666	–	RT 1
-0.8 – 5	0.5 – 1.6	22	25	G 3/8 A <sup>(2)</sup>	<b>017-500166</b> <sup>(1)</sup>	–	–	–	RT 1A
-0.8 – 5	0.5	22	25	G 3/8 A <sup>(2)</sup>	–	–	017-500266	–	RT 1A
-0.8 – 5	1.3 – 2.4	22	25	G 3/8 A <sup>(2)</sup>	017-500766	–	–	–	RT 1A
0.2 – 6	0.25 – 1.2	22	25	G 3/8 A	<b>017-523766</b> <sup>(1)</sup>	–	–	017-524066	RT 200
0.2 – 6	0.25	22	25	G 3/8 A	–	017-523866	017-523966	–	RT 200
1 – 10	0.33 – 1.30	22	25	G 3/8 A	<b>017-520366</b> <sup>(1)</sup>	–	–	017-520066	RT 116
1 – 10	0.33	22	25	G 3/8 A	–	017-520466	017-519966	–	RT 116
4 – 17	1.2 – 4	22	25	G 3/8 A <sup>(2)</sup>	<b>017-525566</b> <sup>(1)</sup>	–	–	–	RT 5
4 – 17	1.2 – 4	22	25	G 3/8 A	–	–	–	017-525366	RT 5
4 – 17	1.2	22	25	G 3/8 A <sup>(2)</sup>	–	017-509466 <sup>(3)</sup>	–	–	RT 5
4 – 17	1.2 – 4	22	25	G 3/8 A <sup>(2)</sup>	<b>017-504666</b> <sup>(1)(3)</sup>	–	–	–	RT 5A
4 – 17	1.3	22	25	G 3/8 A <sup>(2)</sup>	–	017-504766 <sup>(3)</sup>	–	–	RT 5A
10 – 30	1 – 4	42	47	G 3/8 A	<b>017-529566</b> <sup>(1)</sup>	–	–	017-529666	RT 117

<sup>(1)</sup> Preferred versions.

<sup>(2)</sup> Supplied with  $\varnothing 6$  /  $\varnothing 10$  mm weld nipple.

<sup>(3)</sup> With seal cap.

## Pressure switches with adjustable neutral zone

Table 10: Pressure switches with adjustable neutral zone

Regulation range [bar]	Mechanical differential [bar]	Adjustable neutral zone [bar]	Max. working pressure. PS [bar]	Max. test pressure Pe [bar]	Pressure connection	Code no.	Type
-0.8 – 5	0.2	0.2 – 0.9	22	25	G 3/8 A <sup>(2)</sup>	<b>017L003366</b> <sup>(1)</sup>	RT 1AL
0.2 – 3	0.08	0.08 – 0.2	7	8	G 3/8 A	017L001566	RT 110L
0.2 – 6	0.25	0.25 – 0.7	22	25	G 3/8 A	017L003266	RT 200L
4 – 17	0.35	0.35 – 1.4	22	25	G 3/8 A <sup>(2)</sup>	017L004066	RT 5AL
10 – 30	1	1 – 3.0	42	47	G 3/8 A	017L004266	RT 117L

## Pressure switch, Type RT

<sup>(1)</sup> Preferred versions.

<sup>(2)</sup> Supplied with  $\varnothing 6 / \varnothing 10$  mm weld nipple.

### Differential pressure switches

Table 11: Differential pressure switches

Regulation range ( $\Delta p$ ) [bar]	Mechanical differential [bar]	Adjustable neutral zone [bar]	Operation range for LP bellows [bar]	Max. working pressure. PS [bar]	Max. test pressure Pe [bar]	Pressure connection ISO 228/1	Code no.	Type
0 – 0.9	0.05	0.05 – 0.23	-1 – 6	7	8	G 3/8 A <sup>(2)</sup>	017D008166	RT 266AL
0.1 – 1.0	0.05	0.05 – 0.23	-1 – 6	7	8	G 3/8 A <sup>(2)</sup>	017D004566	RT 263AL
0.1 – 1.5	0.1	0.1 – 0.33	-1 – 9	11	13	G 3/8 A <sup>(2)</sup>	017D004366	RT 262AL
0.1 – 1.5	0.1	–	-1 – 9	11	13	G 3/8 A <sup>(2)</sup>	<b>017D002566<sup>(1)</sup></b>	RT 262A
0 – 0.3	0.035	–	-1 – 10	11	13	G 3/8 A <sup>(2)</sup>	017D002766 <sup>(3)</sup>	RT 262A
0.5 – 4	0.3	0.3 – 0.9	-1 – 18	22	25	G 3/8 A <sup>(2)</sup>	017D004866	RT 260AL
0.5 – 4	0.3	–	-1 – 18	22	25	G 3/8 A <sup>(2)</sup>	<b>017D002166<sup>(1)</sup></b>	RT 260A
0.5 – 6	0.5	–	-1 – 36	42	47	G 3/8 A <sup>(2)</sup>	017D002366	RT 260A
1.5 – 11	0.5	–	-1 – 31	42	47	G 3/8 A <sup>(2)</sup>	017D002466	RT 260A
1 – 6	0.5	–	-1 – 36	42	47	G 3/8 A <sup>(2)</sup>	017D007266 <sup>(4)</sup>	RT 265A

<sup>(1)</sup> Preferred versions.

<sup>(2)</sup> Supplied with  $\varnothing 6 / \varnothing 10$  mm nipple.

<sup>(3)</sup> Non-snap action contacts (see [Spare parts and accessories](#), contact system 017-018166).



<sup>(4)</sup> With SPST and SPDT contact system for alarm and cut off function at 0.8 and 1 bar.

### Pressure switches for steam plant

The designation letters mean:

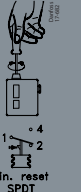

<b>A</b>	Units suitable for ammonia
<b>B</b>	Safety units with external reset
<b>S</b>	Safety units with internal reset
<b>W</b>	Units for control purposes

Table 12: Pressure switches for steam plant, PED approved acc. to EN 12953-9 and EN 12952-11

Regulation range [bar]	Adjustable/ fixed mechanical differential [bar]	Max. working pressure PS [bar]	Max. test pressure Pe [bar]	Pressure connection ISO 228/1	Code no.			Type
								
<b>For rising pressure</b>								
0.1 – 1.1	0.07	7	8	G ½ A	017-528266	–	–	RT 112W
0 – 2.5	0.1	7	8	G ½ A	017-528066	–	–	RT 35W
1 – 10	0.8	22	25	G ½ A	017-518766	–	–	RT 30AW
1 – 10	0.6	22	25	G ½ A	–	017-518866	–	RT 30AB
1 – 10	0.4	22	25	G ½ A	–	<b>017-518966<sup>(1)</sup></b>	–	RT 30AS
5 – 25	1.2	42	47	G ½ A	017-518166	–	–	RT 19W
5 – 25	1	42	47	G ½ A	–	017-518266	–	RT 19B
5 – 25	1	42	47	G ½ A	–	017-518366	–	RT 19S
<b>For falling pressure</b>								
0 – 2.5	0.1	7	8	G ½ A	–	–	017-526266	RT 33B
2 – 10	0.3 – 1	22	25	G ½ A	017-526766	–	–	RT 31W
2 – 10	0.3	22	25	G ½ A	–	–	017-526866	RT 31B
2 – 10	0.3	22	25	G ½ A	–	–	017-526966	RT 31S
5 – 25	0.8 – 3	42	47	G ½ A	017-524766	–	–	RT 32W









## Pressure switch, Type RT

Regulation range [bar]	Adjustable/ fixed mechanical differential [bar]	Max. working pressure PS [bar]	Max. test pressure Pe [bar]	Pressure connection ISO 228/1	Code no.			Type
								
5 – 25	0.4	42	47	G ½ A	–	–	017-524866	RT 32B
<b>Pressure switches for low pressure steam plant (pressure monitoring)- not PED approved</b>								
0.1 – 1.1	0.07 – 0.16	7	7	G ½ A	017-518466	–	–	RT 112

<sup>(1)</sup> Preferred versions.

## Spare parts and accessories

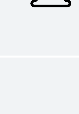
Table 13: Spare parts and accessories

Version	Symbol	Description	Contact rating	Code no.
Standard	 Danfoss 17-9022	Single-pole changeover switch (SPDT) with terminal board proof against leakage current <b>Fitted in all standard versions of type RT.<sup>(1)</sup></b> Snap action changeover contacts	<i>Alternating current:</i> AC-1 (ohmic): 10 A, 400 V AC-3 (inductive): 4 A, 400 V <sup>(2)</sup> Blocked rotor: 28 A, 400 V	017-403066
With max. reset	 Danfoss 17-9023	For manual reset of unit after contact changeover on rising pressure. <b>For units with max. reset.</b>		017-404266
With min. reset	 Danfoss 17-9033	For manual reset of units after contact changeover on falling pressure. <b>For units with min. reset.</b>	<i>Direct current:</i> DC-13: 12 W, 220 V	017-404166
Standard	 Danfoss 17-9026	Single-pole changeover switch (SPDT) with gold plated (oxide-free) contact surfaces. Increases cut-in reliability on alarm and monitoring systems, etc. Snap action changeover contacts. Terminal board proof against leakage current.	<i>Alternating current:</i> AC-1 (ohmic): 10 A, 400 V AC-3 (inductive): 2 A, 400 V AC-15: 1 A, 400 V Blocked rotor: 14 A, 400 V  <i>Direct current:</i> DC-13: 12 W, 220 V	017-424066
Cuts in two circuits simultaneously	 Danfoss 17-9034	Single-pole changeover switch that cuts in two circuits simultaneously on rising pressure. Snap action changeover contacts. Terminal board proof against leakage current.	<i>Alternating current:</i> AC-1 (ohmic): 10 A, 400 V AC-3 (inductive): 3 A, 400 V AC-15: 2 A, 400 V Blocked rotor: 21 A, 400 V  <i>Direct current:</i> DC-13: 12 W, 220 V  <b>NOTE:</b> If current is led through contacts 2 and 4, i.e. terminals 2 and 4 connected but not 1, max. permissible load is increased to 90 W, 220 V.	017-403466
With non-snap action changeover contacts	 Danfoss 17-9024	Single-pole changeover with non-snap action changeover gold plated (oxide-free) contacts.	<i>Alternating or direct current:</i> 25 VA, 24 V	017-018166

<sup>(1)</sup> At load types with low currents/voltages contact failure may occur on the silver contacts because of oxidation. In systems where such a contact failure is of great importance (alarm etc.), gold plated contacts are recommended.

<sup>(2)</sup> According to EN12953-9 and EN12952-11 standards the contact load must not be higher than AC-3: 2 A, 400 V and AC-15: 1 A, 400 V.

### NOTE:

Contact systems for neutral zone units are not available as spare parts. Exchange not possible, as the contact system adjustment is adjusted to the other parts of the unit.

The switch contacts are shown in the position they assume on falling pressure/temperature, i.e. after downward movement of the RT main spindle. The setting pointer of the control shows the scale value at which contact changeover occurs on falling pressure/temperature. An exception is switch no. **017-403066** with max. reset where the setting pointer shows the scale value at which contact changeover occurs on rising pressure.

## Switches

Table 14: Switches











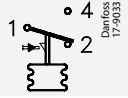

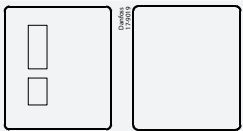

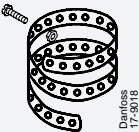

Version	Symbol	Description	Contact rating	Code no.
With min. reset		For manual reset of unit after contact changeover on falling pressure. <b>Gold plated (oxide-free) contact surfaces.</b>	<b>For Alarm application</b> <i>Alternating current</i> AC-1 (ohmic): 10 A, 400 V AC-3 (inductive): 2 A, 400 V Full load current: 2 A, 400 V AC-15: 1 A, 400 V Blocked rotor: 14 A, 400 V	017-404766
With max. reset		For manual reset of unit after contact changeover on rising pressure. <b>Gold plated (oxide-free) contact surfaces.</b>	<i>Direct current</i> DC-13: 12 W, 220 V <b>For control application</b> Max. 100 mA / 30 V AC / DC Min. 1 mA / 5 V AC / DC	017-404866

Table 15: Other parts

Part	Description	Qty.	Code no.
Cover	 Covers: Polyamide (with window) Colour: Pale grey RAL 7035 (without window)	5 5	017-436166 017-436266
Setting knob	 Replacement: Pale grey Ral 7035	30	017-436366
Seal cap	 Seal cap to replace setting knob so that setting can only be altered with tools Colour: Black	20	017-436066
Seal screws for cover and seal cap	 DIN 404	1 + 1	017-425166
Clamping band	 For all RT pressure switches with damping coil or other longer connections L= 392 mm	10	017-420466
Connector with nipple	 Pipe thread ISO 228/1, G 3/8 connector, nipple and AL washer (10 mm ext. 6.5 mm int. diam.) for welding or brazing on to steel or copper tubing	5	017-436866
Connector	 7/16 - 20 UNF connector for 1/4 copper tube, brass, span of jaws 16	10	011L1101
Reducer	 Pipe thread ISO 228/1, G 1/2 A x G 3/8, steel, span of jaws 22	1	017-421966
Adaptor	 Pipe thread ISO 228/1, G 3/8 x 3/8 - 27 NPT with copper washer, brass, span of jaws 22	1	060-333466
Adaptor	 Pipe thread ISO 228/1, G 3/8 A x 1/4 - 18 NPT with copper washer, brass, span of jaws 22	1	060-333566
Adaptor	 Pipe thread ISO 228/1, G 3/8 x 1/4 - 18 NPT with copper washer, brass, span of jaws 22	1	060-333666
Adaptor	 Pipe thread ISO 228/1, G 3/8 A - G 1/4 A, brass, span of jaws 17	1	060-324066
Adaptor	 Pipe thread ISO 228/1, G 3/8 A x R3/8 (ISO 7/1) brass, span of jaws 17	1	060-324166
Damping coil	 Length: 0.50 / 1.00 / 1.50 / 2.00 m Damping coil with 7/16 - 20 UNF connectors. Reducer code no. 017-420566 is necessary if the damping coil is to be used with RT units having a pipe thread ISO 228/1, G 3/8 connection. Damping coils with several lengths of capillary tubes are available. Please contact Danfoss.	1	060-019066 060-019166 060-019266 060-019366

## Pressure switch, Type RT

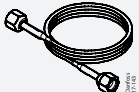
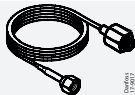
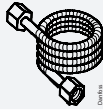
Part		Description	Qty.	Code no.
Damping coil		Pipe thread ISO 228/1, damping coils with G 3/8 connector and 1.5 m copper capillary tube. Standard washers are supplied.	1	060-104766
Armoured damping coil		Pipe thread ISO 228/1, damping coil with G 3/8 connector and 1 m copper capillary tube. Standard washers are supplied.	1	060-333366
Air bell for liquid level control RT 113		Air bell, 62 mm diam. ext. x 204 mm length. Pipe thread ISO 228/1, G 3/8 connector and nipple (10 mm o.d./ 6.5 mm i.d.) for welding or brazing on to steel or copper tubing. The air bell is of brass CuZn 37, W.no. 2.0321.	1	017-401366

## Certificates, declarations, and approvals

The list contains all certificates, declarations, and approvals for this product type. Individual code number may have some or all of these approvals, and certain local approvals may not appear on the list.

Some approvals may change over time. You can check the most current status at danfoss.com or contact your local Danfoss representative if you have any questions.

**Figure 27: Certificates, declarations, and approvals**

RT 1	RT 1A / RT 121	RT 5A	RT 1AL	RT 5	RT 30AW / RT 30AB / RT 30AS / RT 19W / RT 19B / RT 19S	RT 31W / RT 31B / RT 31S / RT 32W / RT 32B	RT 33B / RT 35W / RT 112W	RT 110	RT 112	RT 113	RT 116 / RT 117 / RT 200	RT 117L / RT 200L	RT 260A / RT 262A	RT 265A / RT 260AL / RT 262AL / RT 263AL / RT 266AL	Approvals
•	•	•	•	•	•	•	•	•	•	•	•	•	•	•	CE marked acc. to EN 60947-4/-5
					•	•	•								TÜV, Germany
•				•	•			•	•	•	•				Det Norske Veritas and Germanischer Lloyd, DNV GL
				•				•	•		•				Lloyds Register of Shipping, LR
				•				•	•	•	•				Bureau Veritas, BV
•	•			•				•	•	•	•		•		Registro Italiano Navale, RINA
•	•	•	•	•	•	•	•	•	•	•	•	•	•	•	Russian Maritime Register of shipping, RMRS
•	•	•		•				•	•	•	•				Nippon Kaiji Kyokai, NKK
•	•	•	•	•	•	•	•	•	•	•	•	•	•	•	China Compulsory Certificate, CCC

**NOTE:**

In addition we refer to the certificates, the copies of which can be ordered from Danfoss.

**All RT are:**

- CE marked in accordance with EN 60947-4/-5 for sale in Europe.
- Further, the RT 19, RT 30, RT 35, RT 112 W, RT 33, RT 31 and RT 32 series is CE marked in accordance with PED 2014/68/EU, category IV, safety equipment.

## Online support

Danfoss offers a wide range of support along with our products, including digital product information, software, mobile apps, and expert guidance. See the possibilities below.

### The Danfoss Product Store



The Danfoss Product Store is your one-stop shop for everything product related—no matter where you are in the world or what area of the cooling industry you work in. Get quick access to essential information like product specs, code numbers, technical documentation, certifications, accessories, and more.

Start browsing at [store.danfoss.com](https://store.danfoss.com).

### Find technical documentation



Find the technical documentation you need to get your project up and running. Get direct access to our official collection of data sheets, certificates and declarations, manuals and guides, 3D models and drawings, case stories, brochures, and much more.

Start searching now at [www.danfoss.com/en/service-and-support/documentation](https://www.danfoss.com/en/service-and-support/documentation).

### Danfoss Learning



Danfoss Learning is a free online learning platform. It features courses and materials specifically designed to help engineers, installers, service technicians, and wholesalers better understand the products, applications, industry topics, and trends that will help you do your job better.

Create your Danfoss Learning account for free at [www.danfoss.com/en/service-and-support/learning](https://www.danfoss.com/en/service-and-support/learning).

### Get local information and support



Local Danfoss websites are the main sources for help and information about our company and products. Find product availability, get the latest regional news, or connect with a nearby expert—all in your own language.

Find your local Danfoss website here: [www.danfoss.com/en/choose-region](https://www.danfoss.com/en/choose-region).