

## Data Sheet

# Thermostatic operated water valve Type **AVTA**

Opens on rising sensor temperature



Thermostatic operated water valves are used for proportional regulation of flow quantity, depending on the setting and the sensor temperature.

The Danfoss range of thermostatic operated water valves includes a series of products for both refrigeration and heating regulation. The valves are self-acting, i.e. they operate without the supply of auxiliary energy such as electricity or compressed air.

The required temperature is maintained constant without unnecessary use of:

- cooling water in cooling systems
- hot water or steam in heating systems

The operating economy and efficiency are maximized.

**AVTA SS for aggressive media:**

A valve body in stainless steel means that the valve can be used for aggressive media in such applications as the marine sector and the chemical industry.

## Features

- Insensitive to dirt
- Insensitive to water pressure
- Needs no power supply – self acting
- Opens on rising sensor temperature
- Differential pressure: 0 – 10 bar
- Maximum working pressure (PS): 16 bar
- Maximum test pressure: 25 bar
- Maximum pressure on sensor: 25 bar
- Stainless steel version available
- The valves are pressure-relieved, i.e. degree of opening is not affected by differential pressure  $\Delta p$  (pressure drop).
- The regulation range is defined for the point at which the valve begins to open.
- Cooling media temperature range: -25 – 130 °C
- Ethylene glycol as a cooling media up to 40%

## Functions

### How it works?

When the three elements have been assembled together, the valve installed and the sensor located at the point where the temperature is to be regulated, the function sequence is as follows:

1. The pressure changes in the sensor as a result of a change in temperature - builds up in the sensor.
2. This pressure is transferred to the valve via capillary tube and bellows and acts as an opening or closing force.
3. The knob on the setting section and the spring exert a force that acts counter to the bellows.
4. When balance is created between the two opposing forces, the valve spindle remains in its position.
5. If the sensor temperature changes – or if the settings are changed – the point of balance becomes displaced and the valve spindle moves until balance is re-established, or the valve is fully open or closed.
6. The flow quantity change is approximately proportional to sensor temperature change.

Figure 1 show an AVTA cooling water valve, but the function principle applies to all types of thermostatic valves.

Figure 1: Thermostat operated water valves consist of three main elements

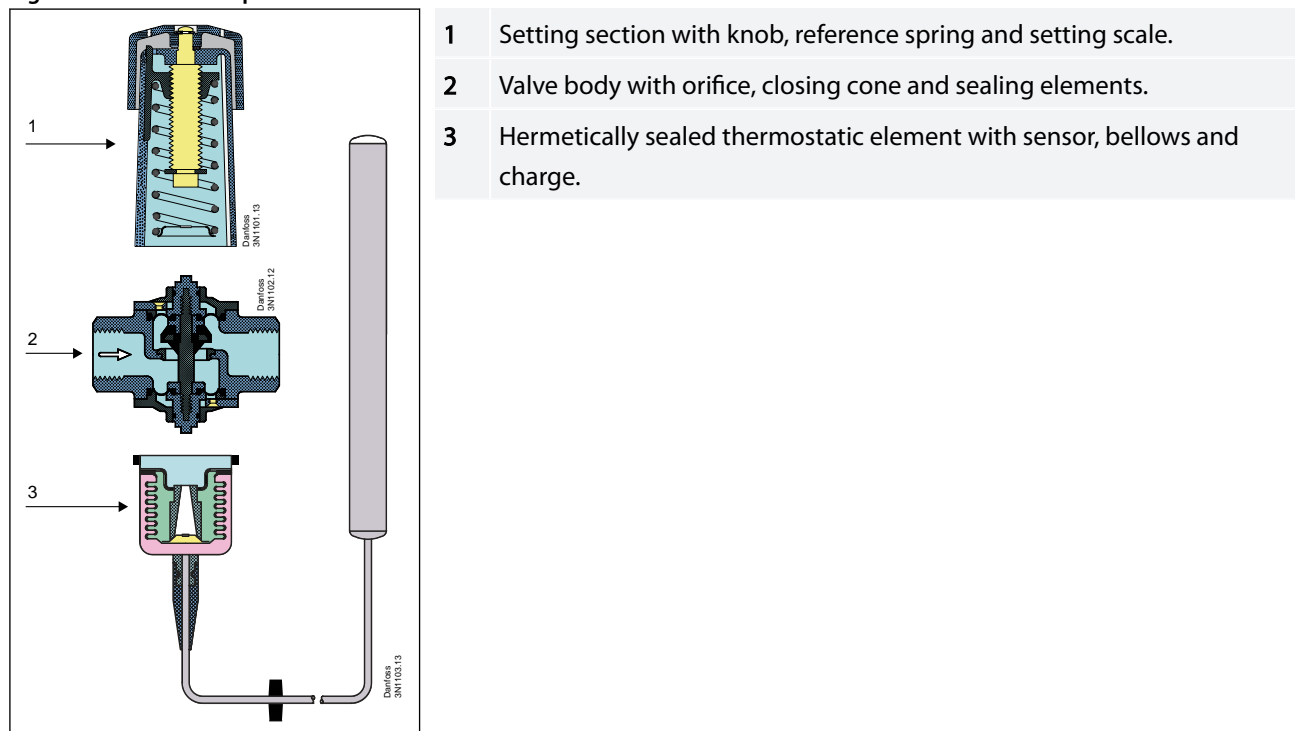

**Applications**

Figure 2: AVTA



AVTA thermo. operated water valves are widely used for temperature regulation in many different machines and installations where cooling is required. AVTA cooling water valves always open to admit flow on rising sensor temperature.

The valve can be installed in either the cooling water flow line or the return line.

The standard version of the AVTA thermo. operated water valve can be used with fresh water or neutral brine.

Typical application areas:

- Injection moulding machines
- Compressors
- Vacuum pumps
- Dry cleaning machines
- Distillation plants
- Printing machines
- Hydraulic systems
- Roller mills
- Biomass boilers
- Industrial lasers
- Steam sterilizers
- Medical equipment
- Food processing

Figure 3: Applications

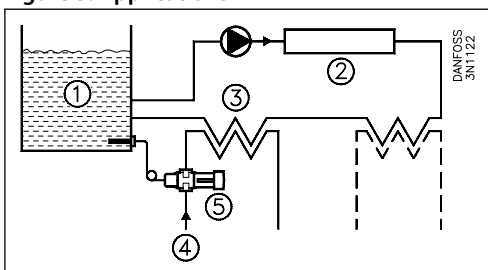

1	Oil tank
2	Hydraulic machinery
3	Heat exchangers
4	Cooling water supply
5	AVTA thermostatic valve

**Product specification**

**Materials**

Figure 4: Materials for AVTA and AVTA SS

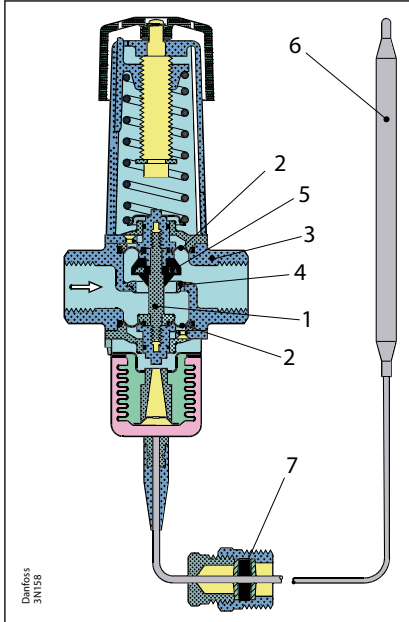

Table 1: Materials

No.	Description	Material AVTA	Material AVTA SS
1	Spindle	Brass	Stainless steel
2	Diaphragms	Rubber – ethylene – propylene (EPDM)	
3	Valve body and other metal parts	Forged brass	Stainless steel
4	Valve seat	Stainless steel	
5	Valve cone	Nitrile rubber (NBR)	
6	Sensor	Copper	
7	Capillary tube gland	Nitrile rubber (NBR) / brass	

**Types of charges**

Table 2: AVTA thermo. operated water valves with different types of charge.



## Installation

### AVTA with mounting bracket

Figure 5: AVTA

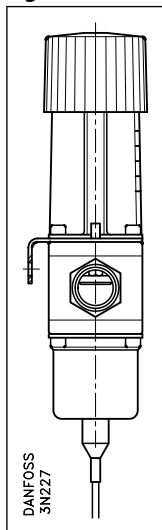

The valves can be installed in any position. An arrow on the valve body indicates the direction of flow.

AVTA valves are marked so that the letters RA are the right way up when the valve is held as shown. The installation of an FV filter ahead of the valve is recommended.

### Capillary tube

Install the capillary tube without sharp bends (no "kinks"). Make sure that there is no strain on the capillary tube at the ends. Relief is important where vibration might occur.

#### **i** NOTE:

When an AVTA valve is used, the sensor must be able to react to variations in cooling water temperature on system start. Therefore a bypass line with a shut-off valve might be necessary to ensure flow at the sensor during start-up. If a mounting bracket is used – see [Accessories](#) and [Spare parts](#) – it must always be positioned between the valve body and the setting section (see illustration).

## Sizing

When sizing and selecting thermo. operated water valves, it is most important to ensure that the valve is able to give the necessary quantity of cooling water at any time, irrespective of the load. Therefore, to select a suitable size of valve it is necessary to know the precise amount of cooling required. On the other hand, to avoid the risk of unstable regulation (hunting), the valve should not be oversized.

The type of charge must be selected on the basis of the temperature to be maintained, and on an assessment of the characteristics of each type, as described in the foregoing.

In general the aim should be to select the smallest valve capable of giving the required flow.

It is also recommended that the temperature range be chosen so that the required sensor temperature lies in the middle of the regulation range.

To help fine-setting the valve, a thermometer should be installed near the sensor.

### Valve size

The following data are used when selecting the valve size:

- Required cooling water flow,  $Q$  [ $m^3/h$ ]
- Temperature rise in cooling water,  $\Delta t$  [ $^{\circ}C$ ]
- Differential pressure across valve,  $\Delta p$  [bar]

## Thermostatic operated water valve, Type AVTA

---

With fully open valve, the differential pressure should be around 50% of the total pressure drop across the cooling system.

The following charts are intended to make valve sizing easier.

[Figure 7: Heating or cooling with water](#)

[Figure 8: Relation between water quantity and pressure drop across valve](#)

[Figure 9: Nomogram showing the valve  \$k\_v\$  range](#)

[Figure 10: Valve flow quantity in fully open position, as a function of pressure drop  \$\Delta p\$ .](#)

### Example:

A cooling water valve must be selected for the temperature regulation of a vacuum pump.

Since direct regulation of the oil temperature is required, an AVTA valve is suitable. The sensor position is horizontal – and small dimensions are desired.

Given data:

- Necessary cooling at full load 10 kW
- Oil temperature to be maintained constant at 45 °C
- Cooling water  $p_1 = 3$  bar
- Outlet  $p_3 = 0$  bar
- $p_2 = \frac{p_2 + p_3}{2}$  (guess)
- Cooling water temperature  $t_1 = 20$  °C
- Outlet temperature  $t_2 = 30$  °C

The graphs in [Figure 7: Heating or cooling with water](#) can be used to find the necessary cooling water quantity at  $\Delta t = 10$  °C (30 – 20 °C) to 0.85 m<sup>3</sup>/h.

The graphs in [Figure 8: Relation between water quantity and pressure drop across valve](#) show the necessary  $k_v$  value for 0.85 m<sup>3</sup>/h with  $\Delta p = p_1 - p_2 = 3 - 1.5 = 1.5$  bar for 0.7 m<sup>3</sup>/h.

The columns in [Figure 9: Nomogram showing the valve  \$k\_v\$  range](#) show that all four AVTA valves can be used, but in practice an AVTA 10 or 15 shall be selected, so the necessary water flow is in the middle of the regulating range.

The above considerations apply to both AVTA and FJVA types.

Operating conditions and other product requirements in this example mean that a valve with adsorption charge is the correct choice. The temperature range 10 – 80 °C is in order.

[Table 4: AVTA with adsorption charge](#) shows AVTA 10, code no. 003N1144, or AVTA 15, code no. 003N0107. Both fulfil the requirements named.

In many applications, installation conditions make the use of sensor pockets advisable.

[Accessories](#) gives the code nos. for sensor pockets for  $\varnothing 9.5$  mm sensors in brass and stainless steel: 017-436766 and 003N0196, respectively.

## Thermostatic operated water valve, Type AVTA

Figure 6: Connection

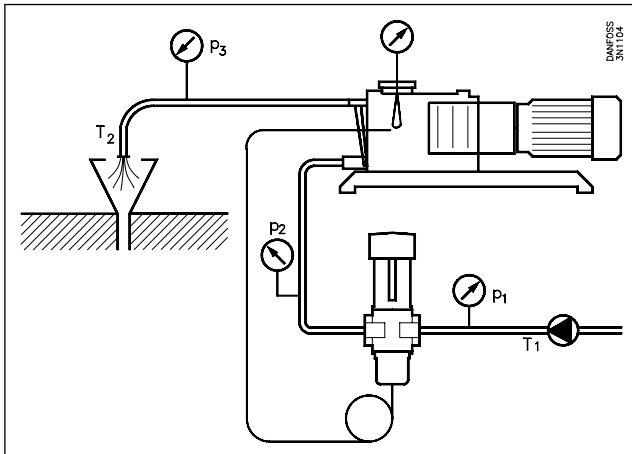
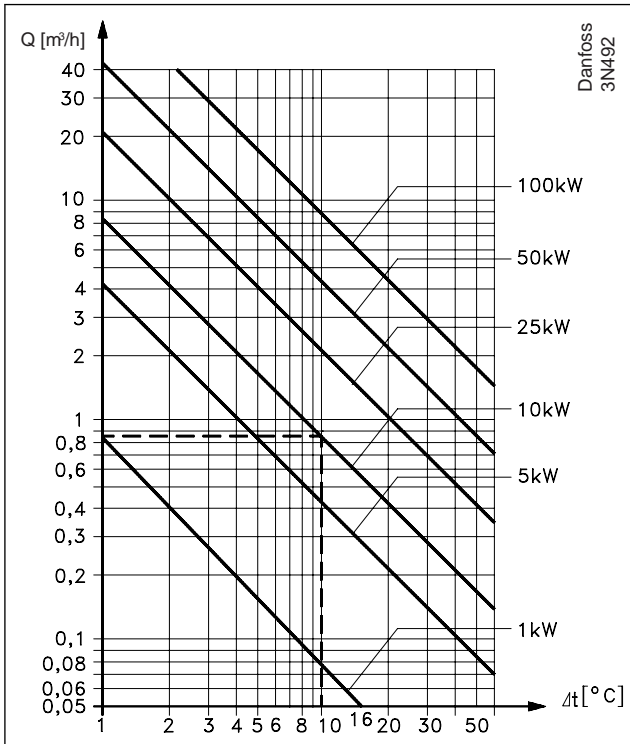

Figure 7: Heating or cooling with water



**Example:**

Necessary cooling output 10 kW with  $\Delta t = 10\text{ }^\circ\text{C}$

Required flow 0.85 m<sup>3</sup>/h



Figure 8: Relation between water quantity and pressure drop across valve

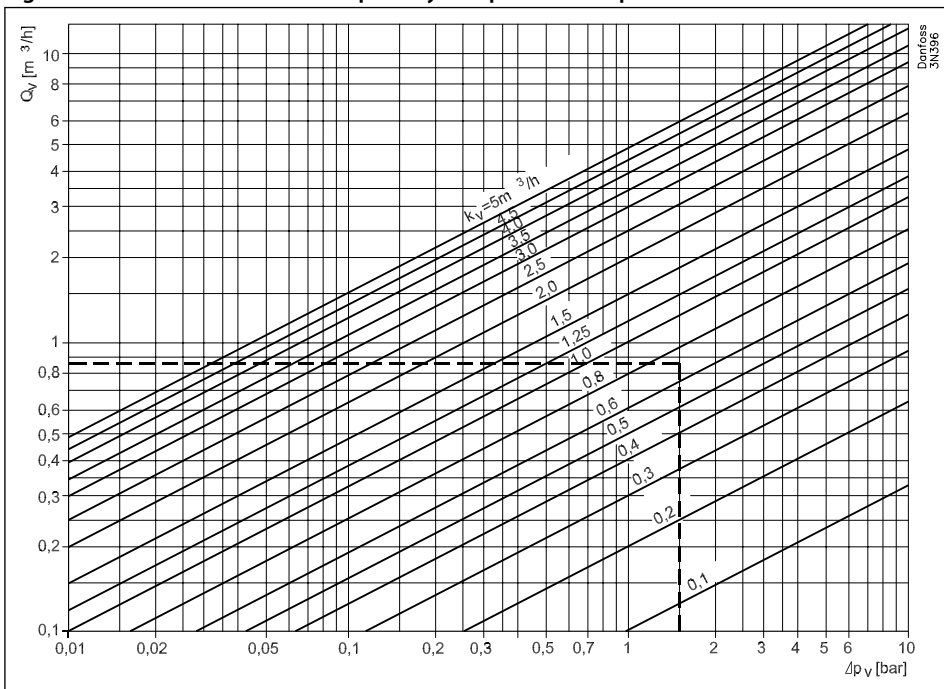

**Example:**

Flow 0.85 m<sup>3</sup>/h with a pressure drop of 1.5 bar.  
 The  $k_v$  value becomes 0.7 m<sup>3</sup>/h.

Figure 9: Nomogram showing the valve  $k_v$  range

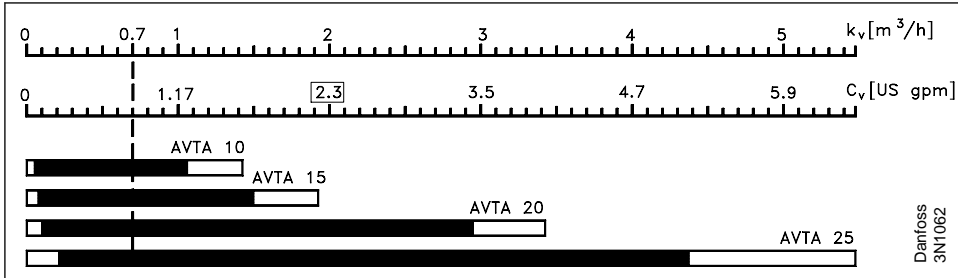

$K_v$  values are always given for water flow in [m<sup>3</sup>/h] with a pressure drop  $\Delta p$  of 1 bar.  
 The valve should be selected so that the necessary  $k_v$  value lies in the middle of the regulation range.

**Example:**

AVTA 10 and 15 are the most suitable for a  $k_v$  value of 0.7

## Thermostatic operated water valve, Type AVTA

Figure 10: Valve flow quantity in fully open position, as a function of pressure drop  $\Delta p$ .

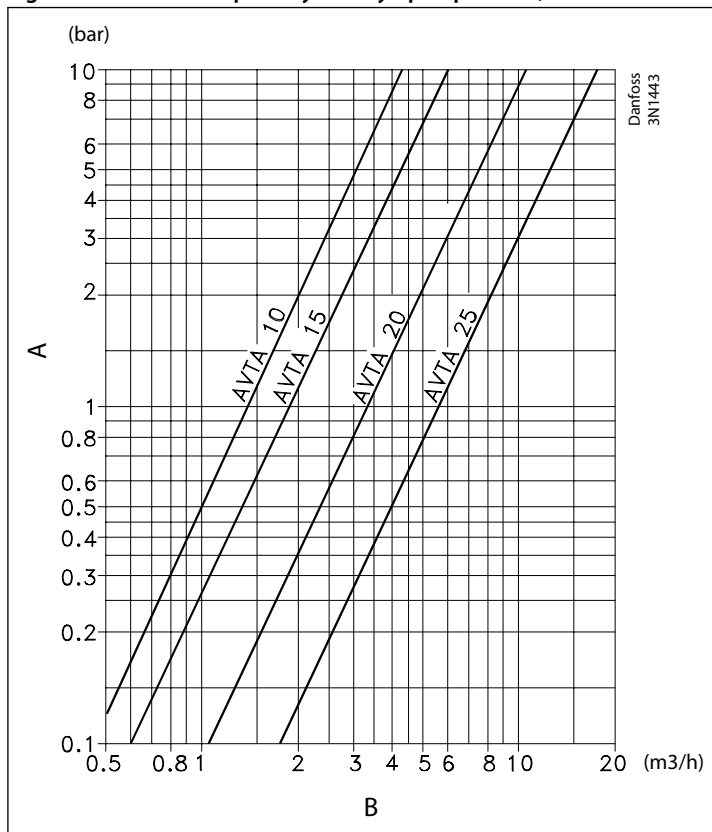

- A Pressure drop across valve
- B Capacity with fully open valve

### Options

- DZR brass
- Outer thread connecting
- Other lengths of capillary tubes
- Armouring of capillary tubes
- Other combinations of sizes, materials and ranges
- NPT – connection, see separate datasheet for USA / Canada

### Dimensions and Weights

Figure 11: Types of sensor

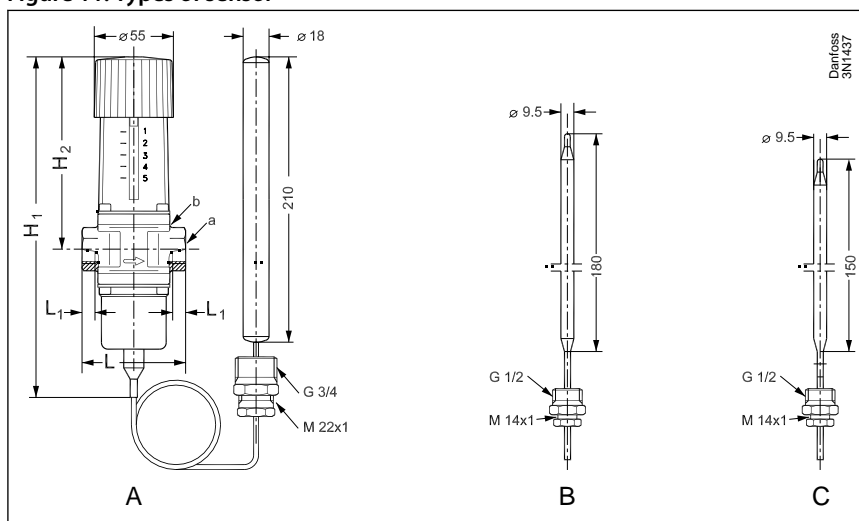

- A Universal sensor
- B Mass sensor
- C Adsorption sensor

## Thermostatic operated water valve, Type AVTA

Figure 12: Valves in brass and stainless steel housings

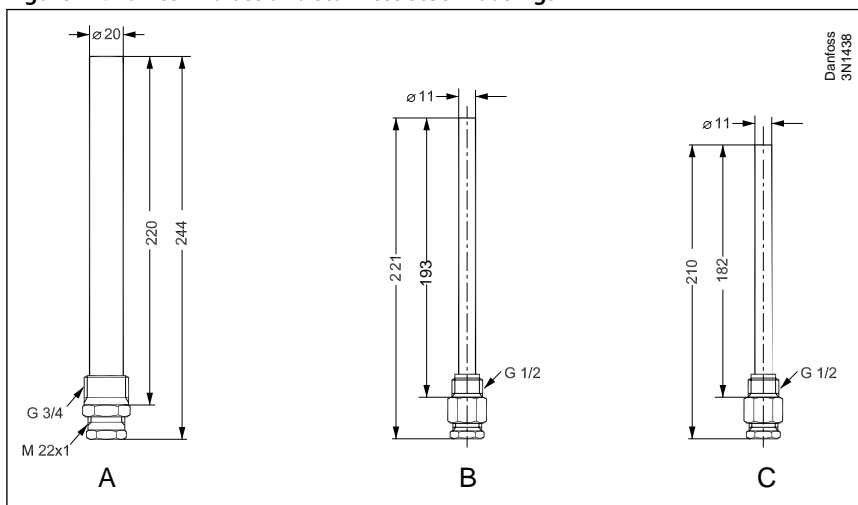

A	Brass/Stainless steel pockets for universal sensor
B	Stainless steel pockets for mass/adsorption sensor
C	Brass pocket for mass/adsorption sensor

### Dimensions [mm] and weights [kg] of AVTA valves in brass and stainless steel housings

Table 3: Dimensions and Weights

Type	H <sub>1</sub>	H <sub>2</sub>	L	L <sub>1</sub>	a	b	Net weight
AVTA 10	240	133	72	14	G 3/8	⬡27	1.45
AVTA 15	240	133	72	14	G 1/2	⬡27	1.45
AVTA 20	240	133	90	16	G 3/4	⬡32	1.5
AVTA 25	240	138	95	19	G 1	⬡41	1.65

## Ordering

### AVTA with adsorption charge

Figure 13: Sensor installation

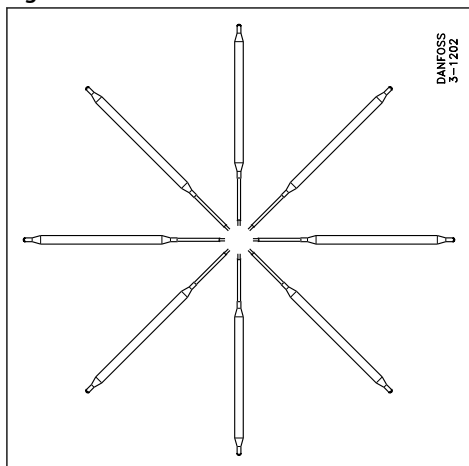

The charge consists of active carbon and CO<sub>2</sub> which is adsorbed on falling sensor temperature, thereby producing a pressure change in the element.

- Wide regulating range
- Can be installed in any position as far as orientation and temperature are concerned
- Small sensor dimensions –  $\varnothing 9.5 \times 150$  mm
- Max. pressure on sensor 25 bar

For immersion pockets, see [Accessories](#) and [Spare parts](#).

Table 4: AVTA with adsorption charge

Connection <sup>(1)</sup>	Regulating range	Max. temp.sensor	k <sub>v</sub> value	Capillary tube length	Type	Code no. <sup>(2)</sup>
	[°C]	[°C]	[m <sup>3</sup> /h] at $\Delta p = 1$ bar	[m]		
G 3/8	10 – 80	130	1.4	2.3	AVTA 10	003N1144
G 1/2	10 – 80	130	1.9	2.3	AVTA 15	003N0107
G 1/2	10 – 80	130	1.9	2.3 (armoured)	AVTA 15	003N2114
G 3/4	10 – 80	130	3.4	2.3	AVTA 20	003N0108
G 1	10 – 80	130	5.5	2.3	AVTA 25	003N0109

<sup>(1)</sup> ISO 228-1.

<sup>(2)</sup> Code no. covers complete valve incl. capillary tube gland.

## AVTA with universal charge

Figure 14: Sensor installation

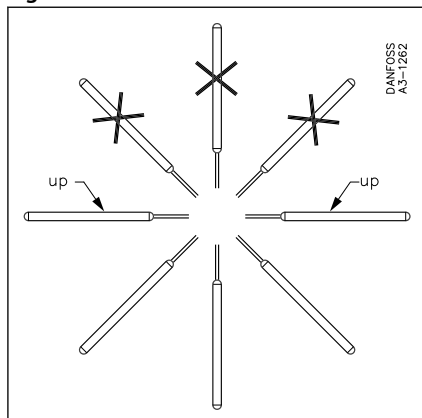
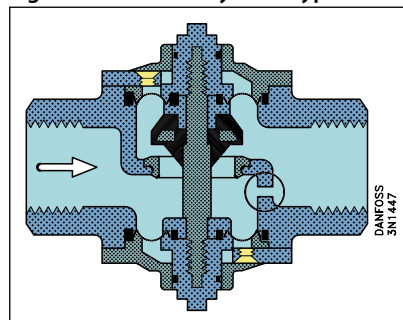

Figure 15: Valve body with bypass



The charge is a mix of liquid and gas where the liquid surface (regulating point) is always inside the sensor. Which charge medium is used depends on the regulation range.

- Sensor dimensions  $\varnothing 18 \times 210$  mm
- Sensor can be installed in a place where it is either colder or warmer than the valve
- Sensors must be orientated as shown in the sketch below
- Max. pressure on sensor 25 bar

For immersion pockets, see [Accessories](#) and [Spare parts](#).

Table 5: AVTA with universal charge

Connection <sup>(1)</sup>	Regulating range	Max. temp. sensor	$k_v$ value	Capillary tube length	Type	Code no. <sup>(2)</sup>
	[°C]	[°C]	[m <sup>3</sup> /h] at $\Delta p = 1$ bar	[m]		
G 3/8	0 – 30	57	1.4	2	AVTA 10	003N1132
G 1/2	0 – 30	57	1.9	2	AVTA 15	003N2132
G 3/4	0 – 30	57	3.4	2	AVTA 20	003N3132
G 1	0 – 30	57	5.5	2	AVTA 25	003N4132
G 3/8	25 – 65	90	1.4	2	AVTA 10	003N1162
G 1/2	25 – 65	90	1.9	2	AVTA 15	003N2162
G 1/2	25 – 65	90	1.9	2.0 (armoured)	AVTA 15	003N0041
G 3/4	25 – 65	90	3.4	2	AVTA 20	003N3162
G 3/4	25 – 65	90	3.4	5	AVTA 20	003N3165
G 3/4	25 – 65	90	3.4	2.0 (armoured)	AVTA 20	003N0031
G 1	25 – 65	90	5.5	2	AVTA 25	003N4162
G 1	25 – 65	90	5.5	2.0 (armoured)	AVTA 25	003N0032
G 1	25 – 65	90	5.5	5	AVTA 25	003N4165
G 3/8	50 – 90	125	1.4	2	AVTA 10	003N1182
G 1/2	50 – 90	125	1.9	2	AVTA 15	003N2182
G 3/4	50 – 90	125	3.4	2	AVTA 20	003N3182
G 1	50 – 90	125	5.5	2	AVTA 25	003N4182
G 1	50 – 90	125	5.5	3	AVTA 25	003N4183 <sup>(3)</sup>

<sup>(1)</sup> ISO 228-1.

<sup>(2)</sup> Code no. covers complete valve incl. capillary tube gland.

<sup>(3)</sup> A  $\varnothing 2$  mm bypass is drilled in the valve body.

## AVTA with mass charge

Figure 16: Sensor installation

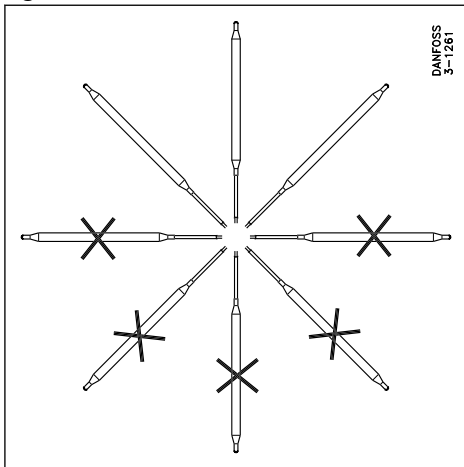

The charge is a mix of liquid and gas. Due to the mixture of liquid and gas the sensor must be installed in an area or environment that is warmer than the valve.

- Small sensor dimensions –  $\varnothing 9.5 \times 180$  mm
- Short time constant
- Max. pressure on sensor 25 bar

Table 6: AVTA with mass charge

Connection <sup>(1)</sup>	Regulating range	Max. temp. sensor	$k_v$ value	Capillary tube length	Type	Code no. <sup>(2)</sup>
	[°C]	[°C]	[m <sup>3</sup> /h] at $\Delta p = 1$ bar	[m]		
G 1/2	0 – 30	57	1.9	2	AVTA 15	003N0042
G 3/4	0 – 30	57	3.4	2	AVTA 20	003N0043
G 1/2	25 – 65	90	1.9	2	AVTA 15	003N0045
G 1/2	25 – 65	90	1.9	2.0 (armoured)	AVTA 15	003N0299
G 1/2	25 – 65	90	1.9	5	AVTA 15	003N0034
G 3/4	25 – 65	90	3.4	2	AVTA 20	003N0046
G 1	25 – 65	90	5.5	2	AVTA 25	003N0047

<sup>(1)</sup> ISO 228-1

<sup>(2)</sup> Code no. covers complete valve incl. capillary tube gland.

## AVTA in Stainless Steel with adsorption charge

Figure 17: Sensor installation

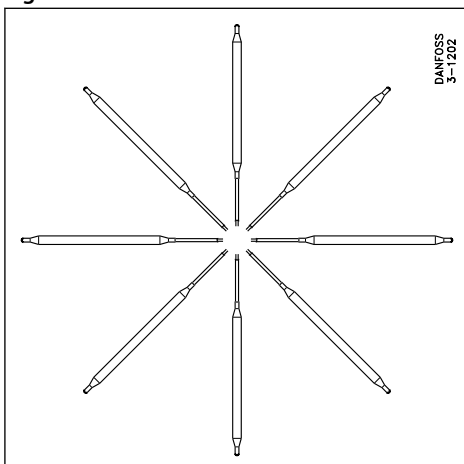

## Thermostatic operated water valve, Type AVTA

- Wide regulating range
- Can be installed in any position as far as orientation and temperature are concerned
- Small sensor dimensions –  $\varnothing 9.5 \times 150$  mm
- Max. pressure on sensor 25 bar
- AVTA SS mass and universal charges available on request

For immersion pockets, see [Accessories](#) and [Spare parts](#).

**Table 7: AVTA in Stainless Steel with adsorption charge**



Connection <sup>(1)</sup>	Regulating range	Max. temp. sensor	$k_v$ value	Capillary tube length	Type	Code no. <sup>(2)</sup>
	[°C]	[°C]	[m <sup>3</sup> /h] at $\Delta p = 1$ bar	[m]		
G 1/2	10 – 80	130	1.9	2.3	AVTA 15	003N2150
G 3/4	10 – 80	130	3.4	2.3	AVTA 20	003N3150
G 1	10 – 80	130	5.5	2.3	AVTA 25	003N4150

<sup>(1)</sup> ISO 228-1.

<sup>(2)</sup> Code no. covers complete valve incl. capillary tube gland.

## Accessories

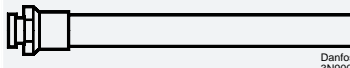
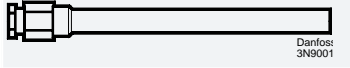
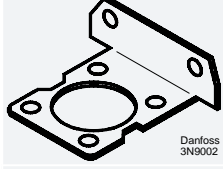
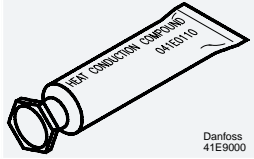
**Table 8: Accessories**

	Designation	Description	Code no.
	Immersion sensor Max. pressure 50 bar L = 220 mm	Brass for $\varnothing 18$ sensor G $\frac{3}{4}$	003N0050
		Brass for $\varnothing 18$ mm, sensor $\frac{3}{4}$ – 14 NPT	003N0051
		18/8 steel <sup>(1)</sup> for $\varnothing 18$ sensor, $\frac{3}{4}$ – 14 NPT	003N0053
		18/8 steel <sup>(1)</sup> for $\varnothing 18$ sensor R $\frac{3}{4}$	003N0192
	Immersion sensor Max. pressure 50 bar L = 182 mm	Brass for $\varnothing 9.5$ sensor G $\frac{1}{2}$	017-436766
		18/8 steel <sup>(1)</sup> for $\varnothing 9.5$ sensor R $\frac{1}{2}$	003N0196
	Mounting bracket	For AVTA	003N0388
	Heat-conductive compound	5 gram tube	041E0110
		0.8 kg	041E0111
	Set of 3 nitrile (NBR) diaphragms sets for mineral oil	For AVTA 10/15, 20, 25	003N0448
	Capillary tube gland	G $\frac{1}{2}$	017-422066
		G $\frac{3}{4}$	003N0155
		$\frac{1}{2}$ – 14 NPT	003N0157
		$\frac{3}{4}$ – 14 NPT	003N0056
	Plastic hand knob	For AVTA	003N0520

<sup>(1)</sup> W. no. 1.4301.

## Spare parts

Figure 18: Thermostatic elements for AVTA valves

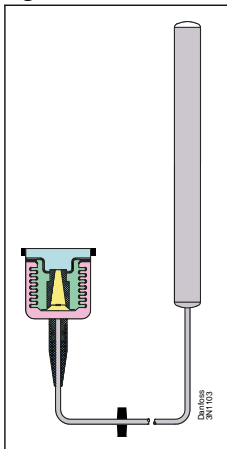

Table 9: Spare parts

Thermostatic Elements	Temperature range	Capillary tube length	Code no.
	[°C]	[m]	
Adsorption charge – sensor $\varnothing 9.5 \times 150$ mm	10 – 80	2.3	003N0278
	0 – 30	2	003N0075
	0 – 30	5	003N0077
Universal charge – sensor $\varnothing 18 \times 210$ mm	25 – 65	2	003N0078
	25 – 65	5	003N0080
	50 – 90	2	003N0062
	25 – 65	2	003N0091
Mass charge – sensor $\varnothing 9.5 \times 180$ mm	25 – 65	2	003N0091
	25 – 65	5	003N0068



## Certificates, declarations, and approvals

The list contains all certificates, declarations, and approvals for this product type. Individual code number may have some or all of these approvals, and certain local approvals may not appear on the list.

Some approvals may change over time. You can check the most current status at [danfoss.com](http://danfoss.com) or contact your local Danfoss representative if you have any questions.

**Table 10: Certificates, declarations, and approvals**

File name	Document type	Document topic	Approvals Authority
003N9617.AA	Manufacturers Declaration	PED/RoHS	Danfoss
003N9614.AA	Manufacturers Declaration	China RoHS	Danfoss
RU Д-ДК.БЛ08.В.00191_18	EAC Declaration	EAC	EAC
UA.089.D.00188-17	UA Declaration	TYSK	TYSK

## Online support

Danfoss offers a wide range of support along with our products, including digital product information, software, mobile apps, and expert guidance. See the possibilities below.

### The Danfoss Product Store



The Danfoss Product Store is your one-stop shop for everything product related—no matter where you are in the world or what area of the cooling industry you work in. Get quick access to essential information like product specs, code numbers, technical documentation, certifications, accessories, and more.

Start browsing at [store.danfoss.com](https://store.danfoss.com).

### Find technical documentation



Find the technical documentation you need to get your project up and running. Get direct access to our official collection of data sheets, certificates and declarations, manuals and guides, 3D models and drawings, case stories, brochures, and much more.

Start searching now at [www.danfoss.com/en/service-and-support/documentation](https://www.danfoss.com/en/service-and-support/documentation).

### Danfoss Learning



Danfoss Learning is a free online learning platform. It features courses and materials specifically designed to help engineers, installers, service technicians, and wholesalers better understand the products, applications, industry topics, and trends that will help you do your job better.

Create your Danfoss Learning account for free at [www.danfoss.com/en/service-and-support/learning](https://www.danfoss.com/en/service-and-support/learning).

### Get local information and support



Local Danfoss websites are the main sources for help and information about our company and products. Find product availability, get the latest regional news, or connect with a nearby expert—all in your own language.

Find your local Danfoss website here: [www.danfoss.com/en/choose-region](https://www.danfoss.com/en/choose-region).